

FC501

Addressable Fire Control Panels



User Manual

This Fire Control panel can be programmed only using the Software **FireClass** Console release 1.0 or higher.

Control panel FW ver. 1.0 or higher.

TYCO shall not assume the responsibility for damage arising from improper application or use. This Control panel has been designed and manufactured to the highest standards of quality and performance. Installation of this Control panel must be carried out strictly in accordance with the instructions described in this manual, and in compliance with the local laws and bylaws in force.

The **FC501-L**, **FC501-H** and **FC501-HK** Fire Control panels comply with the essential requirements of standards **EN54-2: 1997+A1:2006; EN54-4: 1997+A1:2002+A2:2006; EN 54-21**.

The manufacturer reserves the right to change the technical specifications of these products without prior notice.

Recycling information

The manufacturer recommends that customers dispose of their used equipment (panels, detectors, sirens, and other devices) in an environmentally sound manner. Potential methods include reuse of parts or whole products and recycling of products, components, and/or materials.

Waste Electrical and Electronic Equipment (WEEE) Directive



In the European Union, this label indicates that this product should NOT be disposed of with household waste. It should be deposited at an appropriate facility to enable recovery and recycling.

NOTE- The **FC501-L**, **FC501-H** and **FC501-HK** control panel can support several addressable devices (*Detectors, Modules, Manual call Points, etc*). The present manual includes the instructions for their programming, but for further information on those devices and their accessories, please visits: www.fireclass.net.

Maintenance

To ensure that the system continues to operate normally it must be maintained with regular testing by the user and periodic maintenance by the installer in accordance with local laws.

 For the maintenance of other devices such as detectors, modules, etc. follow the dedicated instructions for the devices.

The following operations must be carried out regularly.

A Using a damp cloth (DO NOT USE SOLVENTS OF ANY KIND), remove dust from the Control panel cabinet.

B Using the **Lamp Test** key, check that the LEDs and buzzer are functioning properly.

C Ensure that the batteries are sufficiently charged and functioning properly. If not, replace them immediately.

D Ensure that all cables and connections are intact.

E Ensure that there are no unrelated objects inside the Control panel case.

F Ensure that the control panel is capable of processing a fire alarm and if a siren (sounder) is present in the system, it is activated in consequence of this alarm. If there is a facility for transmission of fire alarm signals to a Central Station, it should also be ensured that the signal is correctly received.

G Also verify the actual functionality of the circuit for the detection of earth fault. The procedure is as follows:

- connect one of the SH terminals of the loop to the panel ground (earth);
 - verify that the fault is reported correctly by the Fire Panel;
 - remove the connection previously made.
- Points **A** and **B** may be carried out by users. Points **C**, **D**, **E**, **F** and **G** must be carried out by qualified persons only.

TABLE OF CONTENTS

INTRODUCTION	5	MODIFY	23
FC501 Fire Control Panel	5	MODIFY MENU	23
<i>Accessory items</i>	5	1 KEY -INIT MSG (Modify panel label)	23
User Access Level	5	2 KEY - User Password	24
		<i>Insert or Modify Password</i>	24
		3 KEY-DAY/NIGHT	24
		<i>Day/Night Mode</i>	24
		4 Key-Time and Date	25
		5 Key- Clear LOG	25
		6 KEY- WALK TEST	26
USER INTERFACE	6	DISABLE	27
Description of Keys	6	1 Key - Disable list	28
<i>Panel Command keys description (Table 1)</i>	6	2 Key - Devices (Disable)	28
<i>Silence/Resound/Sounders</i>	6	<i>Select the Loop</i>	28
<i>Reset</i>	6	<i>Select the Device</i>	28
Key Help	7	<i>Disable device on the Loop</i>	28
Signalling	7	3 Key - SW zone	29
<i>The status LEDs</i>	7	<i>Select SW zone</i>	29
<i>Buzzer (Audible Signals)</i>	7	<i>Disable SW Zone</i>	30
<i>Description of the Repeater FC500REP LEDs</i>	7	4 Key - Outputs	30
DISPLAY	7	<i>Select the Output</i>	30
START-UP PAGE	7	<i>Disable Output</i>	30
FRONT PAGE	9	5 Key - Network	30
MAIN PAGE	9	<i>Select the Network device</i>	30
<i>Diagnostic pages</i>	10	<i>Disable Network device</i>	30
<i>MENU page</i>	10	6 Key - COMMUNIC. (Disable)	31
<i>The EVENT DRIVEN pages</i>	10	<i>Select the COMMUNIC. device</i>	31
WARNING STATUS	10	<i>Disable COMMUNIC. device</i>	31
<i>Delay to Alarm STATUS</i>	11	7 Key-Password (Disable)	32
ALARM STATUS	12	<i>Select the Password</i>	32
FAULT STATUS	13	<i>Disable Password</i>	32
<i>Locate loop break pages</i>	14	8 Key - Fire Relay	32
<i>Locate the not addressed devices</i>	14	Repeater FC500REP Signalling	33
		<i>Description of command Keys</i>	33
		LCD DISPLAY DESCRIPTION	33
		<i>EVENT DRIVEN page description</i>	33
		<i>Description of Status LED</i>	33
VIEW-LOG-PARAMETERS	15		
<i>View parameters</i>	15		
1 KEY - View Loop	16		
<i>View of Loop Details</i>	16		
2 KEY - View Devices	16		
<i>Select the Loop</i>	16		
<i>Select the device</i>	16		
<i>View device data on the Loop</i>	17		
3 KEY- View SW Zone	18		
4 KEY- View Output	18		
5 KEY- View NETWORK	19		
6 KEY- COMMUNICATORS	19		
7 KEY- View Option	20		
8 KEY - View Log	20		
View Log	20		
9 Key - View FW version	21		
0 Key-Panel	21		
View Lists	22		

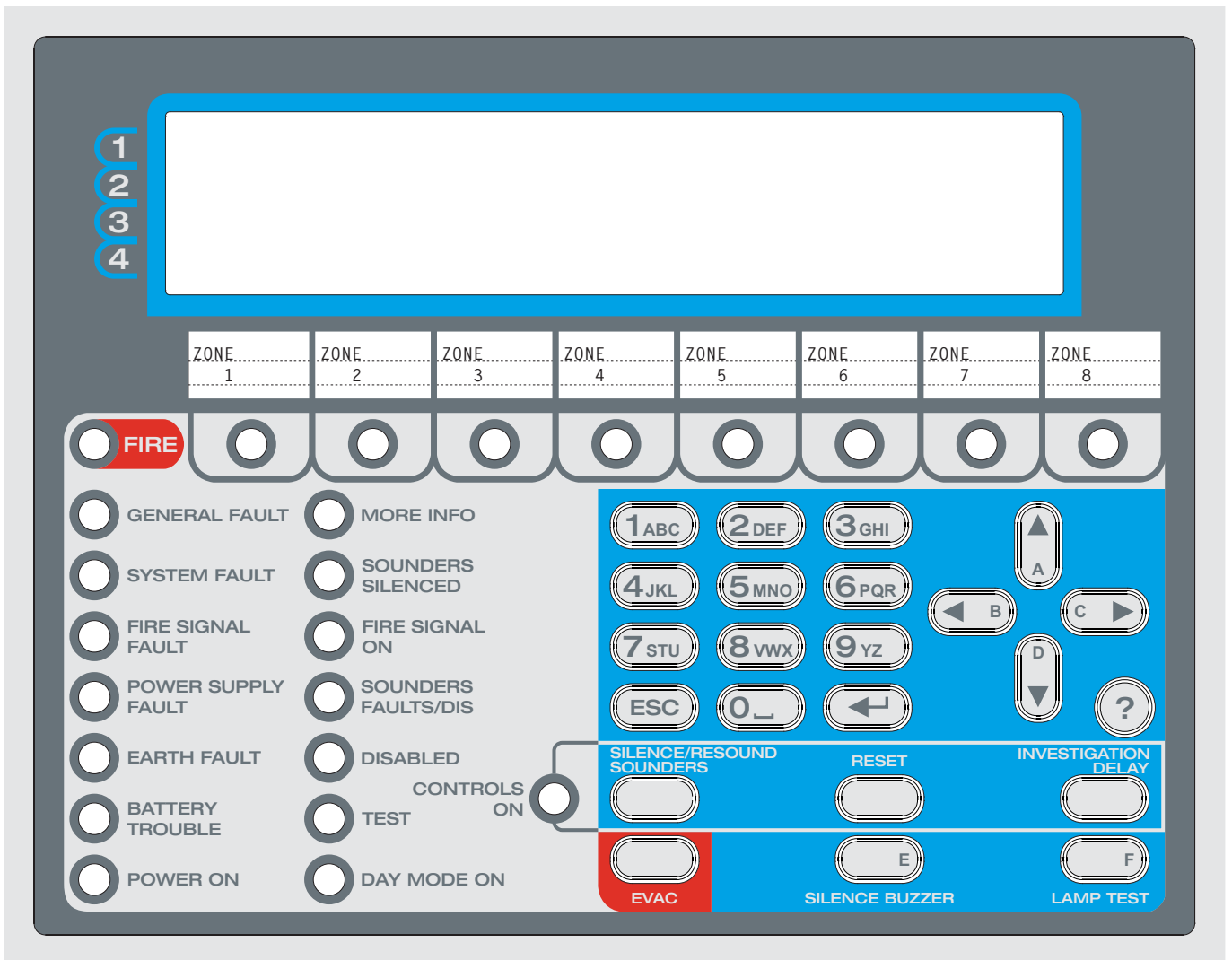

Figure 1 User interface View.

FC501 Fire Control Panel

The FC501 is available in the following models:

- FC501-L - Addressable Control Panel with 3 different and isolated loops, that can support up to **128** addressable devices and 32 zones.

Power Supply: Switching power supply **BAW50T24** (1.8 A @ 27.6 V).

Suitable Batteries: 2 * 12 V/ 7Ah
2 * 12 V/ 12Ah.

User Interface with Icons.

- FC501-H - Addressable Control Panel with 3 different and isolated loops, that can support up to **128** addressable devices and 32 zones.

Power Supply: Switching power supply **BAW75T24** (2,7 A @ 27,6 V).

Suitable Batteries: 2 * 12 V/ 12Ah
2 * 12 V/ 38Ah

User Interface with LEDs descriptions in English.

- FC501-HK: Analogue addressable Fire Control Panel with **3 Loops**, that can support up to **128** addressable device and 32 zones.

Powered: **BAW75T24** Switching Power Supply (2.7 A @ 27.6V).

Suitable batteries: 2 * 12 V/ 12Ah
2 * 12 V/ 38Ah

User Interface with Icons.

 *In this manual, the term FC501 is used to describe the characteristics common to all versions while the version name is used to describe the differences between the versions listed above*

FC501 The FC501 control panel is a modular system. The configuration of the FC501 system depends on the size and requirements of the application, therefore, some of the described devices and functions may not be present on your system.

The FC501 system consists of:

one FC501 control panel,
max 4 FC500REP Repeaters,
max 4 FC500MFI Multifunction Modules,
max 128 devices in three different loops or 128 max in a single loop only.

The FC501 control panel allows users to manage the functions of the Fire control system up to 2000 m (Loop) with shielded cable 2 cores 2x2.5 csa.

■ Accessory items

FC500REP Repeater Repeaters are peripherals that provide all the system status information, emit audible signals and allow users to control the functions of the FC501 system (up to 1000 m, with double twist shielded cable).

FC500MFI FC500MFI is a Programmable Multi functional Module for connection of a real time event printer; The terminal blocks also make it possible to connect a "standard interface" to remotely control and manage a set of Inputs and Outputs to control the panel.

FC500IP Module to connect the control panel to a LAN.

FireClass Console This user-friendly software application (Microsoft Windows XP & above) offers a quick and easy way to program the Control panel and provides event log and print-out functions.

User Access Level

L1= Access level 1: Viewing: **everybody** can view the Control panel status. In detail:

-**ANALYZE** shows the status of the: 1- LOOP, 2- DEVICE, 3- SW ZONES, 4- OUTPUTS, 5- NETWORK, 6- COMMUNIC., 7- OPTIONS, 8- LOG and 9- FW Vers, 0-Panel;

-**VIEW LOG** shows the LOG;

-**VIEW LISTS** shows the lists of: 1- DIS. ZONES, 2- DIS. DEVICES, 3- DIS. PARTS, 4- WALK TEST, 5- FAULTS, 6- WARNINGS and 7- DEV. in TEST.

L2= Access level 2 or User Level: Operating the system (Access Code entered : ONLY **Access Code** can operate the system). At this Level, all the operations at access LEVEL 1 are available and in addition:

-**MODIFY** for: 1- INIT. MSG, 2-USER PASSWORD, 3- DAY/NIGHT, 4- TIME and DATE, 5- Clear LOG, 6- ZONE WALK TEST.

-**DISABLE** for: 1- Dis.LISTS, 2- DEVICES, 3- SW ZONES, 4- OUTPUTS, 5- NETWORK, 6- COMMUNIC., 7- PASSWORD, 8- FIRE relay.

Description of Keys

To manage the panel from the User interface the following controls are used:

- the Alphanumeric keypad;
- the Cursors Keys UP (▲), DOWN (▼), RIGHT (▶) and LEFT (◀);
- ESC Key;
- ENTER Key (↵);
- The Help button (?) to open the **Help** pages on the display (see example in Figure 2).
- The Command Keys.

☞ The Cursors Keys UP, DOWN, RIGHT and LEFT and the Command Keys LAMP TEST and SILENCE BUZZER are used to enter the characters A,B,C,D,E,F respectively, to quickly enter hexadecimal numbers (future use).

The function of the Cursors Keys, ESC key, ENTER Key and Command Keys is different in every LCD display and is fully described in the following pages. Also the pressure time of the keys will have a different use in function of the different LCD display. Use the Help key for explanations.

■ Panel Command keys description (Table 1)

☞ Only the **Lamp Test**, **Silence Buzzer** and **Evacuate** Command buttons can be operated without the access code (access level L1), all the other Command buttons can be operated after the access code is entered (access level L2 and L3)







Key	Icon	DESCRIPTION
Lamp Test		This key can be used to test the buzzer, the LEDs and LCD module. If this key is pressed (when the Control panel is functioning as intended), all the LEDs will glow and the buzzer will emit a continuous beep.
Silence/Resound/Sounders		This key can be used to restore the Silenceable outputs to standby status. Silence status will be held until the Silence key is pressed again in Day Mode , or if the Control panel is operating in Night Mode , until the Night mode Silence time expires or until a new Alarm/Trouble condition is detected.
Investigation Delay		This key can be used to refresh the "Delay to alarm time"; if this key is pressed during "Delay to Alarm", the remaining Delay to Alarm time will be increased with the programmed "Investigation delay".
Silence Buzzer		Key to silence the local buzzer of the control panel; the buzzer will operate every time a new event occurs.
Reset		This key can be used to reset the Fire detectors and restore all outputs to standby status (Supervised/Silenceable outputs, NON-Supervised/Non-Silenceable outputs and Alarm zone outputs).
Evacuation		Key to activate the evacuation ; if this key is pressed, the system will generate an alarm.

Table 1 Command keys description (The icons are not shown on the UK panel.)

■ Silence/Resound/Sounders

The control panel can operate in DAY or NIGHT Mode. If the system is silenced during DAY Mode, SILENCE status will be held until the system is unsilenced (i.e. unless new alarms or faults occur). If the system is silenced during NIGHT Mode, SILENCE status will be held until the Night Mode Silence time expires (refer to "Silence"). On power up (at default) the system will set to DAY Mode. During this operating mode, silenced alarms/faults will not be unsilenced automatically.

☞ This Control panel will generate an Instant Alarm if alarm conditions are detected during **Night Mode** or if an alarm is triggered from a Callpoint.

■ Reset

RESET will stop Alarm, Delay to Alarm, Warning and FAULT conditions. Access to this command is limited to authorized personnel only (installer or user access code). The system will reprocess any alarm, delay to alarm, warning or fault signal which is not cleared by RESET operations. Command keys cannot be used when RESET is running.

The repeaters can be RESET by the installer or user access code.

Key Help ?

To explain the information on the LCD display in the different pages, an embedded help feature is present on the panel LCD display. For each User Interface page active, when the help key is pressed the full text in memory will be scrolled, line by line, in the window of the Help page.

A dedicated text will be present in every page of the User interface.

See the following example: key Help functions for the "Main page". In the following the full text in memory:

- 1- To select Program or Analyze mode.
 - 2- To select Disable or View list mode.
 - 3- Shows the panel event log or select the Modify mode.
 - 4- Select between the function groups related to the keys 1,2,3.
- ENTER:** No action.
ESC: Exit from the HELP to MAIN page, or event driven page, if any.
 Pressing the key for more than 3 seconds the panel will be forced to level 1.
 The **Up** and **Down** key: scroll HELP list.
 No action is related to the **Right** and **Left** key.

Signalling

The system status is indicated by the:

- control panel LEDs;
- back-lighted display (40 characters on 4 lines);
- buzzer.

■ The status LEDs

Table 2 describes how the Control panel LEDs operate, and the actions that can be taken during the various phases signalled on the LEDs.

☞ *During standby status, ONLY the GREEN Mains LED and the Day mode LED (if the control panel is in Day mode) should be On (glowing).*

☞ *The General FAULT LED and the LED relative to the Fault, slow blinking ONLY indicates a FAULT event in memory.*

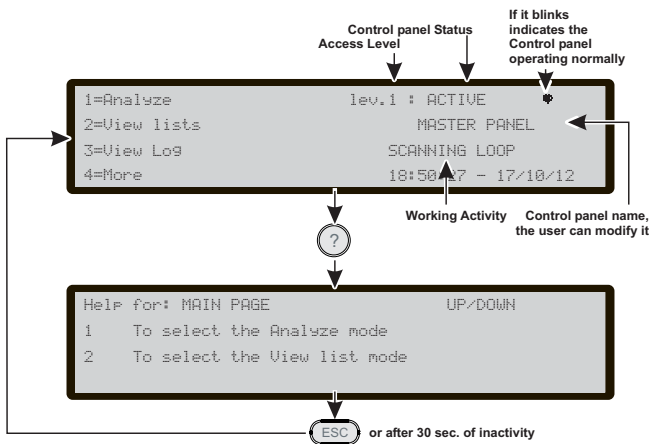

Figure 2 Example of the LCD display after pressing the Help key.

☞ *To manage the brightness and contrast of the LCD display see MAIN page.*

■ Buzzer (Audible Signals)

The control panel buzzer provides audible indication of the panel status. The buzzer signalling is described in the Table 3.

To test the buzzer press LAMP TEST. The buzzer cannot work when the SILENCE Buzzer is pressed.

☞ *When an Alarm status has been silenced and a new Fault signal has been detected, the control panel re-starts the buzzer with the previous Alarm signal.*

■ Description of the Repeater FC500REP LEDs

The table on page 36 describes the function of the LEDs and Keys on the User Interface of the repeater FC500REP.

DISPLAY

The information on the LCD display is organized as pages which include the following:

- START-UP PAGE
- FRONT PAGE
- MAIN PAGE
- DIAGNOSTIC PAGES
- MENU PAGE
- EVENTS DRIVEN PAGE

■ START-UP PAGE

The START-UP page is displayed at the panel start-up if some vital information for the User Interface are not programmed. This information includes:

EVENT DRIVEN PAGES AND MAIN PAGE BASIC INTERACTIONS

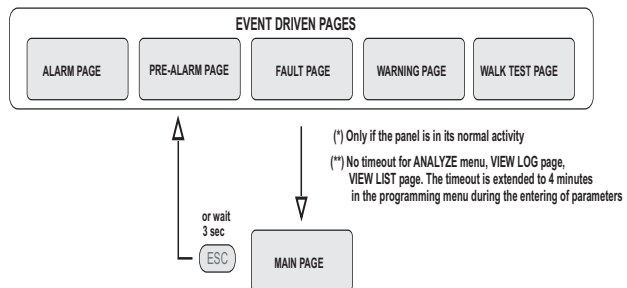

MAIN PAGE, FRONT PAGE AND MENU PAGES BASIC INTERACTIONS

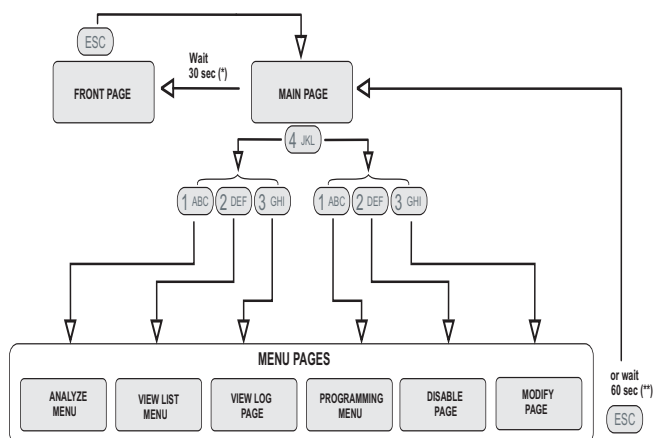

Figure 3 Event driven pages and Main page basic interactions.















LED	ICON	DESCRIPTION
FIRE (Red)		Glowing indicates Alarm status. In the event of an Alarm, the Control panel will activate the unbypassed alarm outputs.
SOFTWARE ZONES (Red) (1-8)	-	Glowing indicates that the corresponding Software zone is in Alarm status (*) . Slow Blinking indicates that the corresponding Software zone is in Delay to Alarm status. OFF indicates no alarms. The zone is in stand-by status.
FIRE SIGNAL ON (Red)		Glowing indicates that transmission was successful. Slow Blinking indicates that transmission is in progress. On the display of the control panel it is possible to know the connection type: PSTN, GSM, or LAN network. OFF indicates the communicator is in stand-by status.
GENERAL FAULT (Amber)		Glowing indicates the presence of a Fault: the following LEDs or the screen on the display indicates the type of the Fault. Slow blinking indicates a fault event in memory (Reset turns OFF). OFF indicates no Fault.
SYSTEM FAULT (Amber)		Glowing (**) indicates a blocked Control Panel. IMPORTANT: Maintenance required. Slow blinking (***) indicates the Control Panel restart. Fast blinking (***) indicates that the panel programming data is corrupted. NOTE – When the Control panel is switched on for the first time, this LED will blink until a Reset has been performed.
FIRE SIGNAL FAULT (Amber)		Glowing indicates the communicator has been disabled. Slow blinking indicates that the communicator has broken down. OFF indicates no fault relative to communicator.
SOUNDERS FAULTS/DIS		Glowing indicates that SC 1 Output is disabled or SC2 "act as SC1" is disabled. Slow blinking indicates that SC1 is in fault or SC2 "act as SC1" is in fault. OFF indicates all the SC outputs function properly.
EARTH FAULT (Amber)		Glowing indicates a Voltage leakage to Earth. IMPORTANT: Check wiring insulation. OFF indicates no Earth faults are present.
BATTERY TROUBLE (Amber)		Glowing indicates Batteries empty or faulty. If this condition persists, the batteries will be unable to function as intended in the event of blackout. IMPORTANT: New batteries required. Slow blinking indicates a fault event in memory (Reset turns OFF). OFF indicates the batteries are healthy.
POWER SUPPLY FAULT (Amber)		Glowing indicates Mains failure. Fast blinking indicates Switching Power supply fault. During this condition, the Control panel will be powered by the batteries. OFF indicates the presence of the Main and the power supply functions properly.
DAY MODE		Glowing indicates that the Control panel is operating in DAY MODE. OFF indicates that the Control panel is operating in NIGHT MODE.
DISABLED		Glowing indicates the Disabled status of any bypassable entity. OFF indicates no entity is disabled.
SOUNDERS SILENCED (Amber)		Glowing indicates that Silenceable outputs and Loop devices have been forced to standby by means of SOUNDER SILENCED key; in Day Mode the SILENCE will remain until the SILENCE key is pressed again, while in Night Mode after the Silence Time expires automatically the SILENCE will end.
Test		Glowing indicates Test conditions on at least one zone. OFF indicates no zone is in Test.
MORE INFO (Amber)		Glowing indicates that there is hidden information with lower priority: access to the page View List to show the hidden information. OFF indicates no hidden information is presents.
CONTROLS ON (AMBER)	-	Glowing indicates that the Control Panel is at least at level 2 so the Silence/Resound Sounders. Reset and Investigation Delay Keys are enabled.
POWER ON (Green)		Glowing indicates panel is supplied with power. OFF indicates Mains failure (both mains & battery power is lost) (Battery disconnect threshold: 19,2 V). Mains Power must be restored before the batteries reach the disconnect threshold.

Table 2 Description of the status LEDs. (*) the zone outside this range (1 to 8) does not have a related LED, its alarm status is displayed only by the LCD, (**)buzzer SYSTEM FAULT pattern, (***)buzzer FAULT pattern, These icons are not shown on the UK User Interface panel.

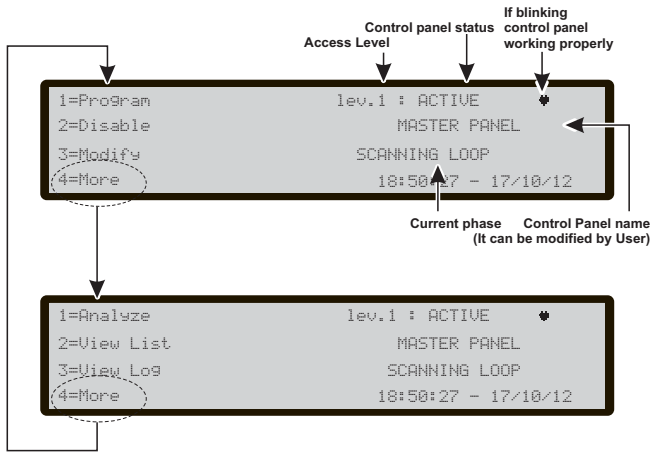

Figure 4 Display MAIN page - Access to the management of the Panel.

- Selected language
 - Panel Identification number
 - The panel type (FC501-I/FC501-H)
 - The installed battery capacity (7Ah/12Ah/38Ah)
- The selected language is vital for the User Interface to select between the two available languages in the panel. The panel Identification number is vital for the panel to name and manage the files over the USB memory stick.

During the start-up page, the panel is not fully operative and the controls keys are not working

■ FRONT PAGE

The FRONT page is normally displayed when the panel is in Stand-by status. It can contain an advertisement message set by the installer. The page content and the enablement to display it are set by the FC500 Console SW.

Alphanumeric keypad No function is related to the Alphanumeric keypad.

Cursor keys No function is related to the UP, DOWN, RIGHT and LEFT keys.

Condition	Frequency (Hz)	Sound	Pause
SYSTEM FAULT (main processor fail)	1300	2.5 s	2.8 s
GENERAL FAULT (Programming data corrupted)	660	1 s	1 s
Alarm	3300	0.2 s	0.2 s
Fault	660	1 s	1 s
Delay to alarm	880	0.5 s	0.5 s
Warning	440	2 s	2 s
Reset	No sound		
Test	No sound		

Table 3 Buzzer Signalling.

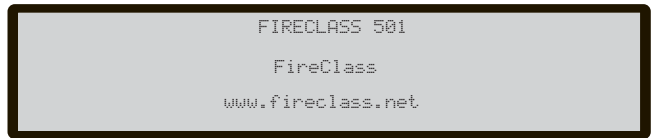

Figure 5 Display FRONT page (stand-by status).

ESC Key Exit from the FRONT page, moves the User Interface to MAIN page or EVENT DRIVEN page, activated directly by Events: WARNING, DELAY TO ALARM, ALARM, FAULT or WALK TEST.

ENTER Key No function is related to the ENTER key.

To permanently remove the FRONT PAGE, it may be re-activated downloading into the panel a new front page using the FireClass Console SW (see Screen saver Menu in the Installation Manual)

■ MAIN PAGE

This is the first page displayed by the panel after the power-up (see Figure 4). This page can be replaced by the EVENT DRIVEN page.

When the panel starts its normal activity and no accesses to the User Interface are sensed for a period of 30 seconds, the User Interface leaves the MAIN page and reaches the FRONT page.

The access level field shows the current access level of the panel. 10 seconds before leaving the present access level this field starts to blink.

The panel mode field displays the current panel mode, the possible values include "ACTIVE " where the panel is active (its normal state).

A continuous and steady panel blinking indicates that the panel is functioning properly.

The panel activity field displays the current activity of the panel, the possible values are:

- "RESETTING " The panel is resetting.
- "LOC. PROG " The panel is being programmed by a local access.
- "REM.ACCESS" The panel is remotely accessed (PC via serial port, USB or IP).
- "SYS. INIT " The panel is initializing.
- "SYS. VER: " The panel is verifying itself.
- "CLEAR LOG " The panel is clearing the event log.
- " WAITS " The panel is waiting to be configured.
- " _____ " No activity.
- "IS SCANNING LOOP" The panel is in its normal activity.

The date and time field blinks until the date and time is set.

In this phase:

Alphanumeric keypad The **1** key moves the panel to **Program** or **Disable** mode.

The **2** key moves the panel to **Analyze** or **View lists** mode.

The **3** key shows the panel **View log** or moves the panel to the **Modify** mode.

The **4** key selects between the function groups related to the keys 1,2,3.

Cursor keys The **UP** Key increases the brightness of LCD display.

the **Down** Key decreases the brightness of LCD display.

the **Right** Key increases the contrast of LCD display.

the **Left** Key decreases the contrast of LCD display.

ESC Key Exit from the MAIN page, moves the User Interface to FRONT page or EVENT DRIVEN page. Pressing the key for more than 3 seconds. the panel will be forced to access Level 1.

ENTER Key No function is related to the ENTER key.

Diagnostic pages

These pages allow:

- the display of some electrical parameters inside the panel (Panel meter page)
- the display of some functional parameters related to the loops (LOOP page)
- To execute the panel keyboard test (KEYBOARD TEST page).

These pages are reached during the normal operation from the Main page after a long pressing key **4**.

MENU page

The MENU pages allow access to the PROGRAM, ANALYZE, DISABLE and MODIFY features of the panel. The part relating to the User will be explained in the sections of this manual: ANALYZE, DISABLE and MODIFY. The part relative to the Installer will be explained in the section PROGRAM in the Installer manual.

The EVENT DRIVEN pages

The EVENT DRIVEN pages are activated by events in the system and when they become active, they override the page present on the display at that time. An EVENT DRIVEN page may be overridden by another EVENT DRIVEN page that has a higher priority.

The following table contains the EVENT DRIVEN page priority assignment:

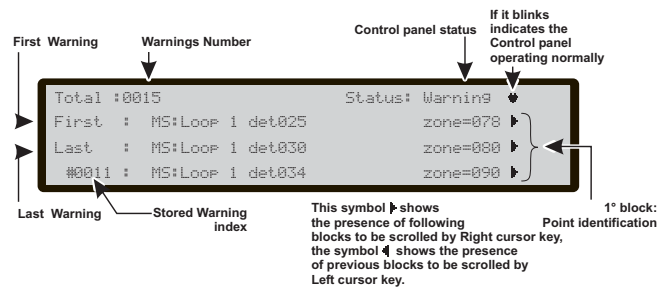



Figure 6 DISPLAY: WARNING STATUS

The Event Driven pages	Priority
ALARM	0 (highest)
DELAY TO ALARM	1
FAULT	2
WARNING	3
WALK TEST	4 (Lowest)

In the case of lower priority Event pages (one or more) being suppressed by the highest priority Event page, the MORE INFO LED  is ON. In this condition, the suppressed EVENT pages may be manually reached using the **View list**. entry in the **MAIN** page.

WARNING STATUS

The FC501 fire control panel can be programmed to provide WARNINGS or DELAY TO ALARMS status before ALARM status.

The Warning status will be signalled by the WARNING display (see Figure 6). The panel will generate a warning when an input point (detector) exceeds its warning threshold and there is risk of an alarm.

WARNING STATUS will be signalled by:

- Warning output points;
- fire control panel Display;
- intermittent audible signal on the panel buzzer;
- the FC500REP repeater.

In this phase:

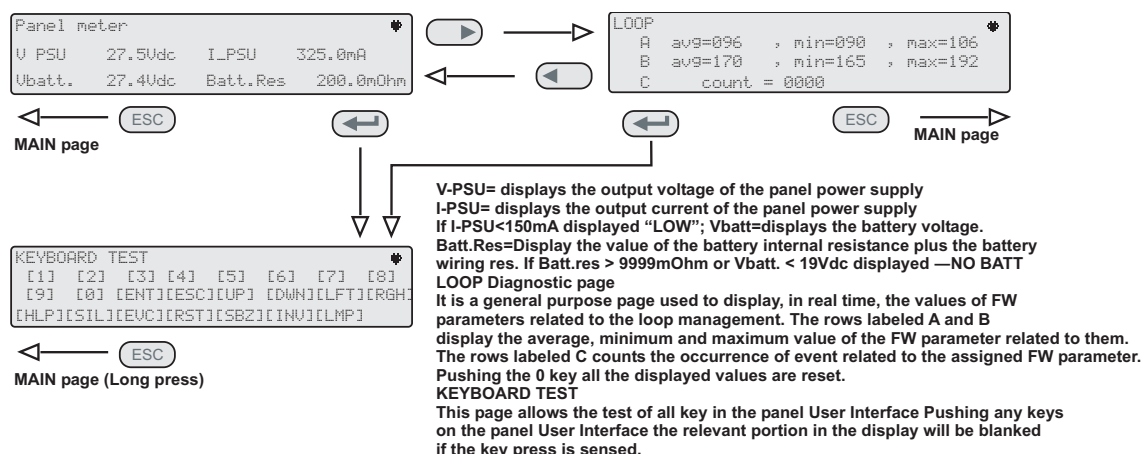

Figure 7 Interaction between the Diagnostic pages.

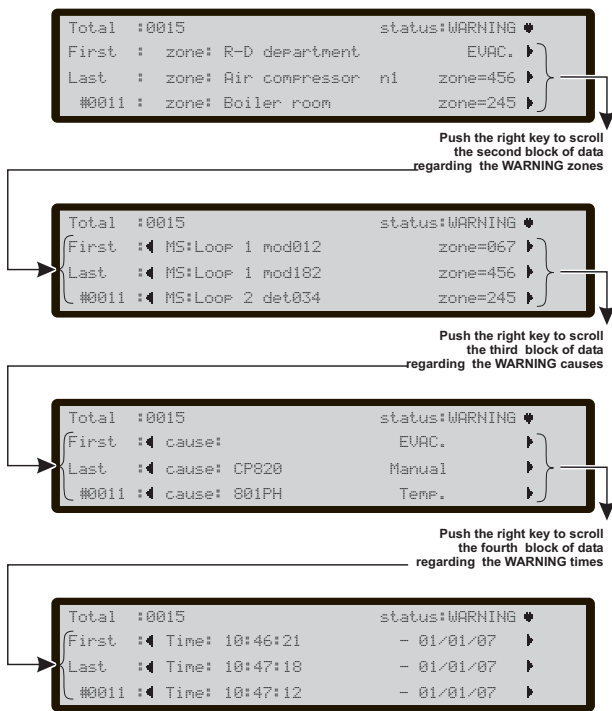

Figure 8 Warning status - Scrolling Right key.

Alphanumeric keypad 0 key: if the **Warning** is related to an item that may be disabled, the User Interface moves to the disabling page. The following key functions allow for a fast disablement procedure:

- 1 key: to jump to the Zone status visualization page;
- 2 key: if the first Warning is related to a point, jump to loop device status visualization page;
- 3 key: if the last Warning is related to a point, jump to loop device status visualization page;
- 4 key: to display further Warning.

When a point Warning is present in the fourth row, a further 4 key press will cause the User Interface to jump to the related loop device status visualization page.

From Figure 6, in the WARNING STATUS, use the **RIGHT** Key to scroll the second string of data of **Warning Zones**; then use the **RIGHT** Key to scroll the third string of data of **Warning causes**; then use the **RIGHT** Key to scroll the fourth string of data of **Warning Times** and **Events**.

Hand icon: If the events are linked to the devices, the zone label alternates with the point label every 3 seconds. If the zone has not been associated with the point, only the point label will appear.

Cursor keys Use the **UP** Key to view the next event, other than the first and the last; Use the **DOWN** Key to view the previous event, other than the first and the last. Use the **RIGHT** Key to view the next string of data. Use the **LEFT** Key to view the previous string of data.

ESC Key Use **ESC** key to cancel the operation and to step back to MAIN page.

ENTER Key The **ENTER** Key blocks/reactivates the exchange between the labels of the devices and those of the

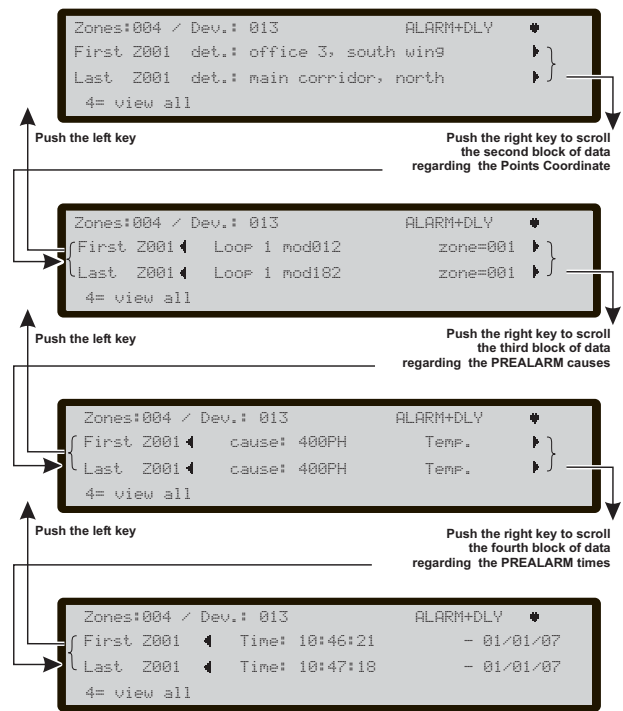

Figure 9 Delay to alarm status - Scrolling Right key.

zones. When the block is enabled, the @ character appears in the top left-hand corner of the display.

■ Delay to Alarm STATUS

This status indicates that an input point (detector) has exceeded its alarm threshold. The fire control panel will not generate an alarm until the preset delay to alarm-time ends. However, if a second input point (detector in the same SW zone) detects alarm conditions during the Delay to Alarm phase (and the “Double knock” option has been programmed for that zone), the fire control panel will generate an instant alarm.

If the fire control panel is operating in NIGHT mode, it will generate INSTANT ALARMS ONLY (Delay to Alarm status will be bypassed automatically). If an alarm procedure is already running, the fire control panel will ignore delay to alarm conditions.

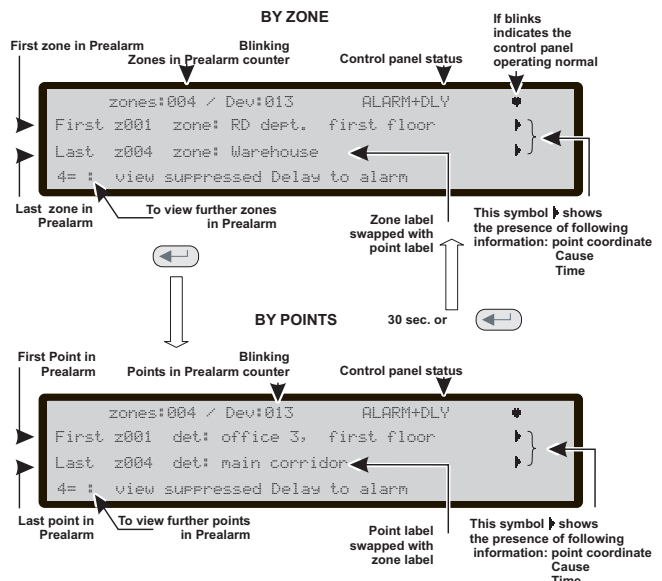

Figure 10 Display: DELAY TO ALARM STATUS.

☞ The EN54-2 requires that at the least, the first zone in Delay to Alarm, the most recent zone in Delay to Alarm and the number of zones in Delay to Alarm will be displayed.
Besides to supply the information about the points in Delay to Alarm, the visualization of the Delay to Alarm will be by zones (default) or by points.

Delay to Alarm status will also be signalled by:

- on fire control panel Display;
- the LED (1-8) relative the zone in Delay to Alarm mode slow blinking;
- an intermittent audible signal on the control panel buzzer;
- the delay to alarm output points.

During the Delay to Alarm phase you will be able to SILENCE, INVESTIGATE or RESET the system and view the LOG.
The Display in Figure 10 shows that the fire control panel is in Delay to Alarm STATUS: in this phase:

Alphanumeric keypad For the Delay to Alarm by **ZONES** or by **POINTS** the use is the same:

- 1 key: to jump to the Zone status visualization page;
- 2 key: to jump to the first activated loop device status visualization page;
- 3 key: to jump to the last activated loop device status visualization page ;
- 4 key: to display further Points in Delay to Alarm.

When a point information is present in the fourth row, a further 4 key press will cause the User Interface to jump to the related loop device status visualization page.

Cursor keys For the Delay to Alarm by **ZONES** or by **POINTS** the use is the same:

- the **UP** Key to view the next available point in Delay to Alarm, other than the first and the last;
- the **DOWN** Key to view the previous available point in alarm, other than the first and the last.

The **RIGHT Key** to display the next auxiliary information about the point (see Figure 9);
The **LEFT Key** to display the previous auxiliary information about the point.

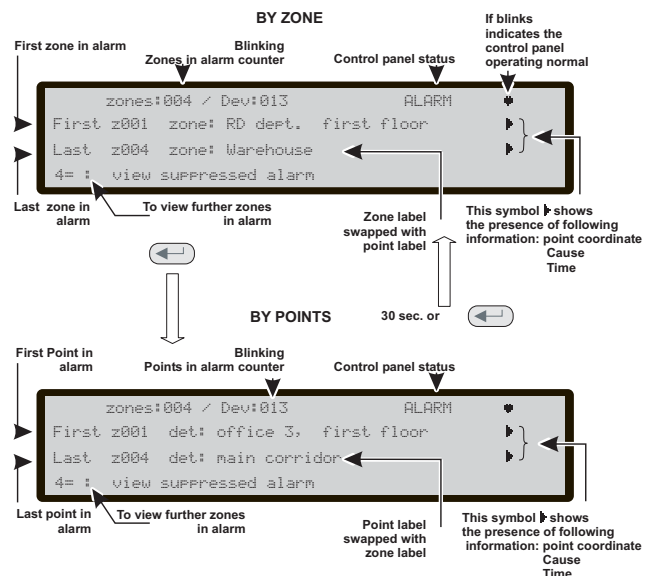

Figure 12 DISPLAY: ALARM STATUS.

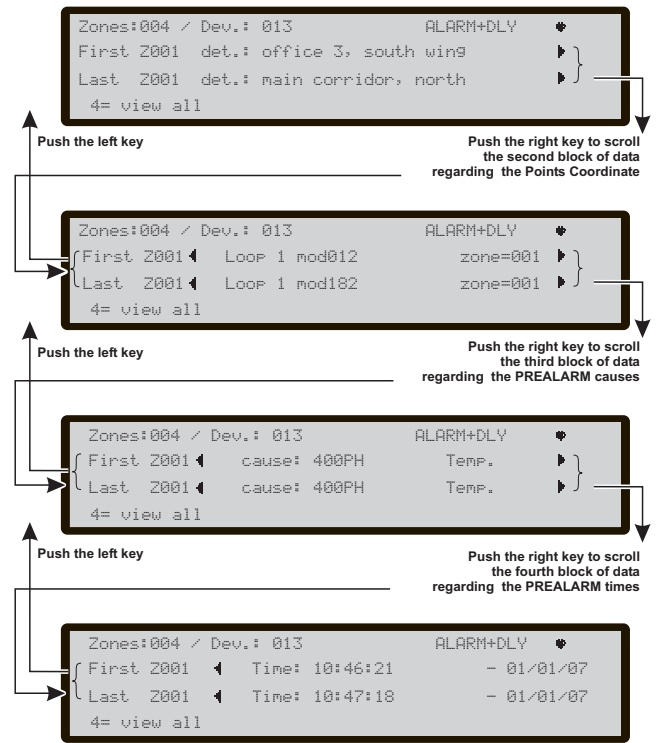

Figure 11 Alarm status- Scrolling Right key.

ESC Key ESC key to step back to the MAIN page.

ENTER Key Long press - change between the visualization modes;
Short press - stops or restarts the zone/point swap.

☞ Functional notes: the point related to the first zone in Delay to Alarm is the first point in the zone that becomes active. For all other zones in Delay to Alarm the related point is the last that becomes active. This information is updated in real time.
The "first point in Delay to Alarm" field contains the information about the first device that becomes active.
The "last point in Delay to Alarm field contains the information about the last activated point, no matter which zone it belongs to.

ALARM STATUS

In the ALARM status, an alarm has been raised by a detector or manual call point.

ALARM status will also be signalled by:

- blinking ALARM LEDs.
- message on fire control panel/Repeater Display (see Figure 12).
- an intermittent audible signal on the fire control panel.
- the Alarm output points, programmed to signal the Alarm status. In this phase:

☞ The EN54-2 requires that at the least, the first zone in alarm, the most recent zone in alarm and the number of zones in alarm will be displayed.
Besides supplying the information about the points in alarm, the visualization of the alarm will be by zones (default) or by points.

Alphanumeric keypad For the alarm by **ZONES** or by **POINTS** the use is the same:

1 key: to jump to the Zone status visualization page;

In the FC500REP repeater case in addition to press F1 key, you have to press ENTER key to visualize the zone label.

2 key: to jump to the first activated loop device status visualization page.

3 key: to jump to the last activated loop device status visualization page.

4 key: to display further Points in alarm.

When point information is present in the fourth row, a further **4** key press will cause the User Interface to jump to the related loop device status visualization page.

Cursor keys For the alarm by **ZONES** or by **POINTS** the use is the same:

Use the **UP** Key to view the next point in alarm, other than the first and the last.

Use the **DOWN** Key to view the previous point in alarm, other than the first and the last.

Use the **RIGHT** Key to display the next auxiliary information about the point.

Use the **LEFT** Key to display the previous auxiliary information about the point.

ESC Key Use **ESC** key to step back to the MAIN page.

ENTER Key Long press - change between the visualization modes.

Short press - stops or restarts the zone/point swap.

Functional notes: the point related to the first zone in alarm is the first point in the zone that becomes active. For all other zones in alarm the related point is the last that became active. This information is updated in real time.

The "first point in alarm" field contains the information about the first device that becomes active.

The "last point in alarm" field contains the information about the last activated point, no matter on which zone belong.

For the WALK TEST status, displays and procedures are similar to the FAULT status

■ FAULT STATUS

FAULT status will also be signalled by:

- blinking FAULT LEDs.
- message on fire control panel Display.

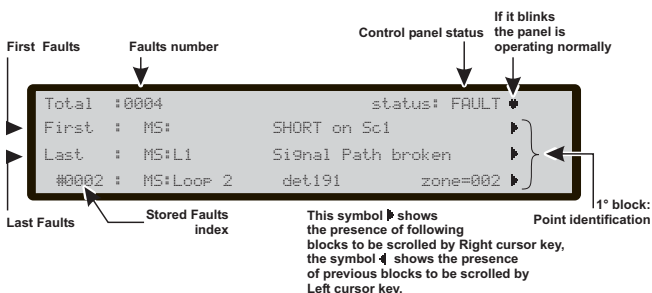

Figure 13 DISPLAY: FAULT STATUS.

- blinking the specific FAULT LEDs, if present (POWER SUPPLY FAULT - BATTERY TROUBLE-EARTH FAULT-SYSTEM FAULT-FIRE SIGNAL FAULT- SOUNDERS FAULT/DIS).
- an intermittent audible signal on the fire control panel.
- the Fault output points.

Figure 13 shows the Fault status of the control panel. The SILENCE button can be used to force the FAULT Silenceable output momentarily to standby status. FAULT MEMORY will be signalled by blinking on the FAULT LEDs ONLY.

The RESET key can be used to force ALL Fault outputs to standby and clear the fault memory. The fault outputs will restore automatically to standby when faults clear. In this phase:

Alphanumeric keypad Use the **1** key to jump to the Zone status visualization page.

Use the **2** key if the first fault is related to a point, jump to loop device status visualization page.

If the first fault is a loop break fault, jump to the "locate the loop break" page.

If the first fault is related to an item that may be disabled, the User Interface moves to the disabling page, allowing fast disablement procedure.

If the access level is less than L2, the password will be required before proceed to disablement

Use the **3** key if the last fault is related to a point, jump to loop device status visualization page.

If the last fault is a loop break fault, jump to the "locate the loop break" page.

If the last fault is related to an item that can be disabled, the User Interface moves to the disabling page, in order to allow a fast disablement procedure.

If the access level is less than L2, the password will be required before proceed to disablement

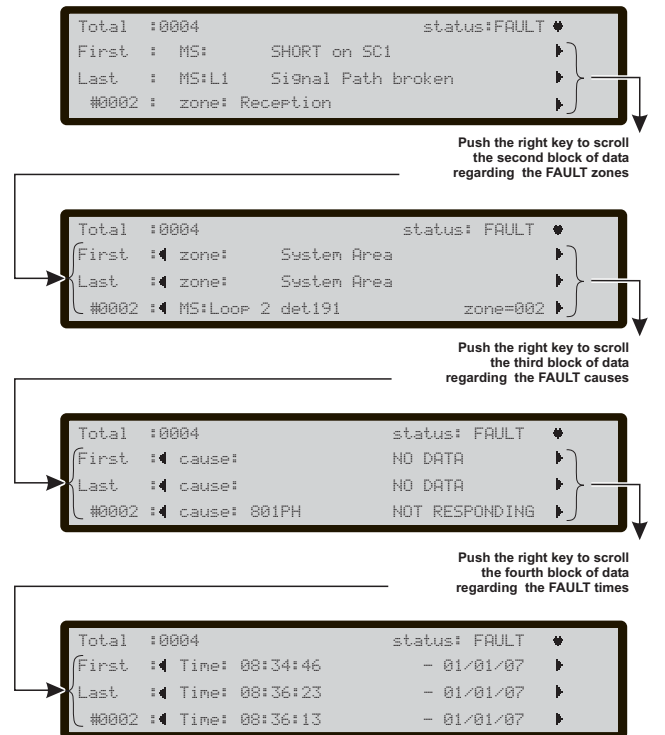

Figure 14 Fault status- Scrolling Right key.

Use the **4** key to display further faults.

When a point fault is present in the fourth row, a further **4** key press will cause the User Interface jump to the related loop device status visualization page.

When a point fault is present in the fourth row, a further **4** key press will cause the User Interface jump to the “locate the loop break” page. If there is a fault related to an item that may be disabled present in the fourth row, the User Interface moves to the disabling page in order to allow a fast disablement procedure.

👉 *If the access level is less than L2, the password will be required before proceed to disablement*

From Figure 14, in the FAULT STATUS, use the **RIGHT** Key to scroll the second string of data of **fault Zones**; after use the **RIGHT** Key to scroll the third string of data of **Fault causes**; then use the **RIGHT** Key to scroll the fourth string of data of **Fault Times** and **Events**.

👉 *In the case that a fault is related to a Loop device, the faulty point label is swapped with the assigned zone label every 3 seconds. If the zone has not been associated with the point, only the point label will appear.*

Cursor keys Use the **UP** Key to view the next available fault, other than the first and the last.

Use the **DOWN** Key to view the previous available fault, other than the first and the last.

Use the **RIGHT** Key to view the next auxiliary information about the point.

Use the **LEFT** Key to view the previous auxiliary information about the point .

ESC Key Use the **ESC** key to step back to the MAIN page.

ENTER Key The **ENTER** Key blocks/reactivates the exchange between the labels of the devices and those of the zones.

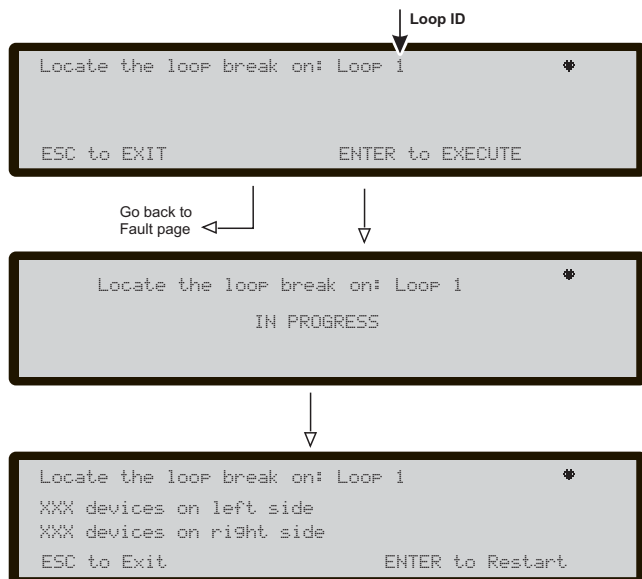

Figure 15 Page "Locate loop break".

■ Locate loop break pages

From paragraph Fault status - 2 Key.

These pages are used to manage the “locate loop break” procedure that helps to understand where the loop is broken. The results of this procedure provide the number of sensed detector on the left and on the right side of the analyzed loop.

The page's sequence is depicted in figure 15.

👉 *Note that during the “locate loop break” procedure all the detectors will be powered down. At the exit of the procedure, a full loop initialization will be executed.*

👉 *During the “locate loop break” procedure, the devices not in configuration are not found.*

👉 *In the immediate future, in the case of short circuit on a loop, the control panel will indicate a fault for a short circuit on the other loops. Only later, with “locate loop break” procedure, it is possible to see which of the three Loop occurred on short circuit.*

■ Locate the not addressed devices

In the case of “NOT PROGRAMMED DEV.”, fault it is possible to locate all the not addressed devices.

To make visible all the not addressed devices that have a LED, they will be activated (steady on).

The sounders will start to sound, while the beacons will start to flash.

The following pictures display the “locate not addressed device page” diagram flow.

If there are too many not addressed devices, the overall current required to keep active all the LEDs, sounders and beacons at the same time, may be so high that the loop overcurrent protection circuit is triggered.

For this reason the operator is warned about this possibility.

👉 *This feature is made available only when the panel reaches its stand-by status (scanning loop).*

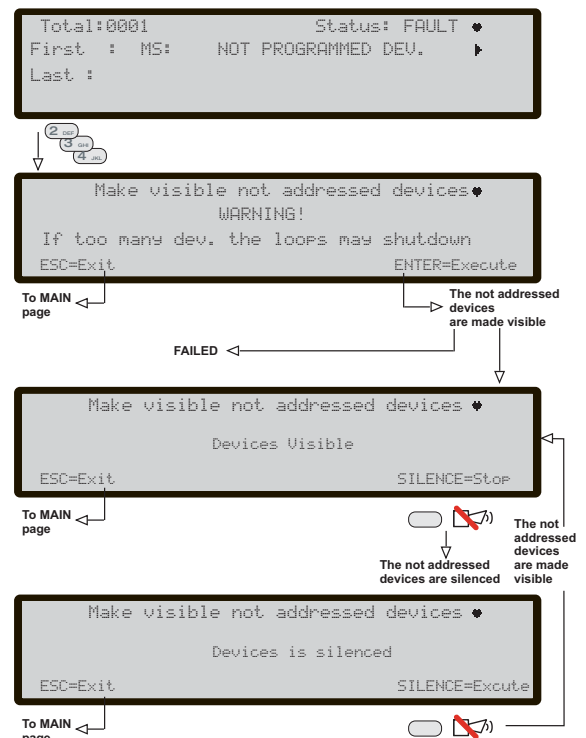

Figure 16 Locate the not addressed devices pages.

VIEW-LOG-PARAMETERS

Read through the following section carefully to get an overall view of how to use the Programming for the Users. For details regarding the parameters of each phase, refer to the respective paragraph in the "PROGRAMMING FROM A PC" chapter of the Installation Manual.

From the Main Page, the User can manage without **Access code**:

- **View parameters** (Use 1=ANALYZE)
 - **View Log** (Use 3= View LOG or 1=ANALYZE and then use 8 Key)
 - **View Lists** (Use 4= MORE and then 2)
- and with **User Access code** can manage this menu:
- **Modify**
 - **Disable**

■ View parameters

Figure 17 shows how to manage the viewing of different parameters:

In this phase:

Alphanumeric keypad Use the Alphanumeric keypad to select the different viewing functions:

- 1= Loop**: start the procedure for selection and viewing of the loop data;
- 2=** To activate the selection and visualization sequence of the loop devices real time data;
- 3 = SW zone**: activates the selection and display procedure for the data corresponding to all SW zones;
- 4 = Output**: activates the selection and viewing procedure for the data corresponding to an output;
- 5= Network**: start the procedure for viewing of all devices (Repeaters and MFI module) on the RS485 Network;
- 6 = Communic**: activates the viewing sequence for all communication units main data;
- 7 = Option**: activates the viewing sequence for all locally programmed system options;
- 8= Log**: start the procedure for viewing of Logged events;
- 9= Fw ver.**: start the procedure for viewing of FW version of all processors in the panel;
- 0= Panel**: start the procedure for viewing Panel informations.

Cursor keys No function is related to the **UP,Down, Right** and **Left** key.

ESC Key Use the **ESC** key to step back to MAIN page.

ENTER Key No function is related to the **ENTER** key.

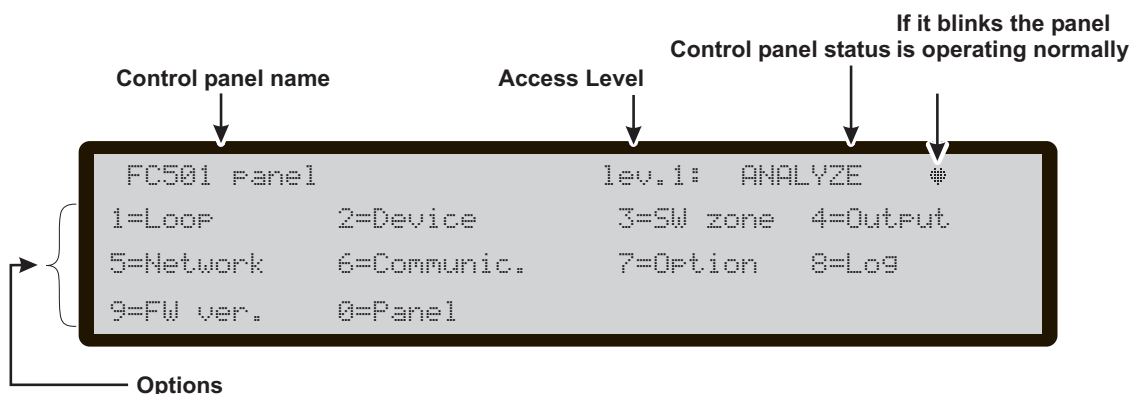

Figure 17 Display: View Parameters.

1 KEY - View Loop

Use the 1 Key to view the Loop data (see Figure 17).

■ View of Loop Details

In this phase:

Alphanumeric keypad No function is related to Alphanumeric keypad.

Cursor Keys Use the **UP** Key to select the next Loop data;

Use the **Down** Key to select the previous Loop data;

No function is related to the **Right** Key;

No function is related to the **Left** Key.

ESC Key Use **ESC** key to step back to previous page.

ENTER Key No function is related to the **ENTER** key.

In the Figure 19, the “loop=” field shows which loop detail is displayed.

The “Detectors:” field displays the number of detectors sensed on the relevant loop.

The “Modules:” field displays the number of modules sensed on the relevant loop.

The “Status:” field displays the status of the selected loop. The possible values are:

- Working,
- Fault,
- Stand_by,
- Disabled.

The “loop=” field real time display (5 seconds data refresh rate) the total current supplied to all three loops.

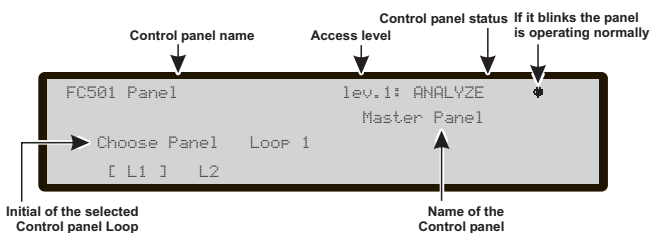

Figure 18 Display: viewing a) Loop choice, b) Loop details.

2 KEY - View Devices

Use the 2 Key to view the Loop devices (see Figure 18). In this page: Select the Loop and then the device.

■ Select the Loop

In this phase:

Alphanumeric keypad 1,2,3 used to select the loop.

Cursor Keys No function is related to **UP** Key; No function is related to the **Down** Key; Use the **Right** Key to select the next available Loop; Use the **Left** Key to select the previous available Loop.

ESC Key Use the **ESC** key to cancel the operation and to step back to previous page.

ENTER key Use the **ENTER** key to confirm and to display the page of the selected Loop.

■ Select the device

After selecting the Loop, the Loop details are shown as in Figure 20.

In this phase:

Alphanumeric keypad Use the Alphanumeric keypad to insert the device address. If the address does not exist the next available device will be selected.

If the device is in the system, the square brackets will be shown near the address. If the address does not exist or it is different from that selected in the underlying bar, the arrows will be shown.

Cursor Keys No function is related to the **UP** Key; No function is related to the **Down** Key; Use the **Right** Key to select the next available Device; Use the **Left** Key to select the previous available device.

ESC Key Use the **ESC** key to cancel the operation and to step back to previous page.

ENTER key Use the **ENTER** key to confirm and to display the page of the selected device.

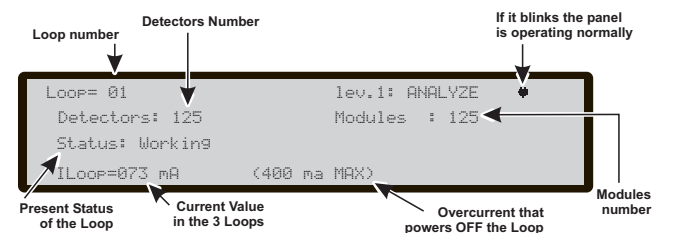

Figure 19 DISPLAY: Viewing Loop details.

■ View device data on the Loop

Select the Loop and then the device, the Display will show Figure 20.

In this phase:

Alphanumeric keypad No function is related to the Alphanumeric keypad except 0 key to disable the device (detector or module), it will require the entry of the access code if the access level is less than 2.

NOTE: This feature does not work in the case of multichannel module not answering to loop poll.

Cursor Keys The **UP** Key, in the case of modules with several inputs or outputs, can scroll through them; The **Down** Key in the case of modules with several inputs or outputs, can scroll through them; the **Right Key**: displays the status of the next device on the same loop; the **Left Key**: displays the status of the previous device on the same loop; in the case of modules with several inputs or outputs, this means it is possible to scroll through them.

ESC Key Use the **ESC** key to cancel the operation and to step back to previous page.

ENTER key No function is related to the **ENTER** key.

The Device status field displays the current status of the **detector** or **module**, the possible values are:

- WORKING
- ACTIVE
- WARNING
- FAULT
- ZONE DIS.
- WALK TEST
- STAND-BY.

The device coordinate field displays:

- the loop ID,
- the device address,
- the device type,
- the channel ID (for the modules).

The “Device channels info area” displays:

- the channel ID S=Smoke, T=temperature, C=Carbon monoxide (for the detector),
- the current analog value in percentage,
- a real time, pseudo-graphic representation of the current analog value with threshold,
- the channel configuration mode or the threshold value
- the channel status.

NOTE: The device information is displayed only in the case of devices in **WORKING** state.

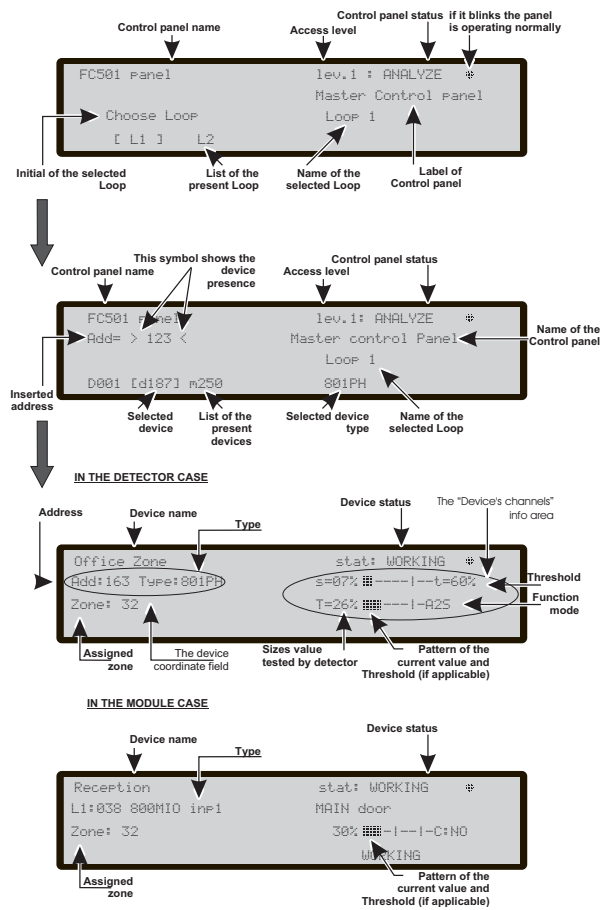

Figure 20 Following displays of View devices on the Loop (Detectors and Modules).

3 KEY- View SW Zone

The **3 Key (SW Zone)** option in the ANALYZE menu activates the viewing of the software zones (max 32). During this phase (see Figure 21) the status of all the SW zones in the system is displayed in compact format. The status of the SW zones will be displayed using the following abbreviations:

- . : "UNUSED" Not used zone, no devices assigned to it
- A**: "ALARM" zone in Alarm mode
- P**: "PRE AL." zone in Delay to alarm mode
- W**: "WARNING" zone in Warning mode
- F**: "FAULT" zone in Fault mode
- X**: "DISABLED" zone Disabled
- t**: "TEST" zone in Test mode
- T**: "TEST ON" At least one point in the zone is active in test
- _**: "ST-BY" zone in standby mode
- D**: "DIRTY" At least one smoke detector in the zone is dirty.

Alphanumeric keypad No function is related to Alphanumeric keypad.

Cursor Keys No function is related to **UP** key. No function is related to the **Down** key; the **Right Key**: selects the next SW zone, in the "All zone status area"; (the corresponding number appears on the Left of the display); the **Left Key**: selects the previous SW zone, in the "All zone status area"; (the corresponding number appears on the Left of the display).

ESC Key Use **ESC** key to cancel the operation and to step back to previous page.

ENTER key No function is related to ENTER key.

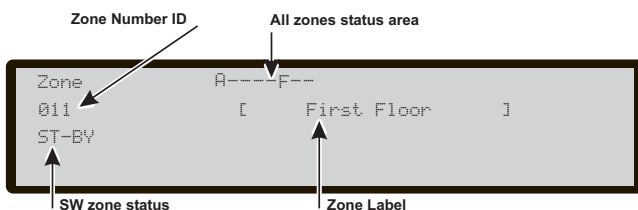

Figure 21 Display view SW zone.

4 KEY- View Output

The **4 key Output** option in the ANALYZE menu activates the viewing of the Outputs. During this phase (see Figure 22) the status of all the Outputs in the system is displayed in compact format. The status of the Outputs will be displayed using the following abbreviations:

- DIS: output disabled
- ACT: output active
- SC: output shorted
- OPE: output open
- __ : output in standby
- FAU: transistor Fault

Alphanumeric keypad No function is related to Alphanumeric keypad.

Cursor Keys No function is related to the **UP, Down, Right and Left** key.

ESC Key Use the **ESC** key to cancel the operation and to step back to previous page.

ENTER key No function is related to the **ENTER** key.

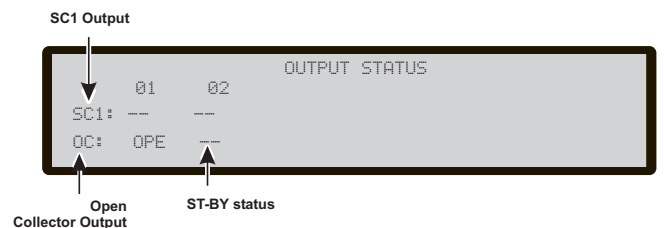

Figure 22 Display view Outputs.

5 KEY- View NETWORK

Use the **5 Key** to view the Network devices: MFI modules (max 4) and Repeaters (max 4) (see Figure 23).

The field Network devices status displays the related output status using abbreviations.

The abbreviations are:

- “ OK!”, the net. device is sensed as connected and working
- “ Ko!”, the net. device is sensed as not connected
- “ FAU”, the net. device is faulty
- “ DIS”, the net. device is disabled
- “ — ”, the net. device is not configured in the network
- “ OLD”, the net. device has an obsolete FW version.

In this phase:

Alphanumeric keypad No function is related to Alphanumeric keypad.

Cursor Keys No function is related to the **UP, Down, Right, Left Key**.

ESC Key Use the **ESC** key to cancel the operation and to step back to previous page.

ENTER key No function is related to the **ENTER** key.

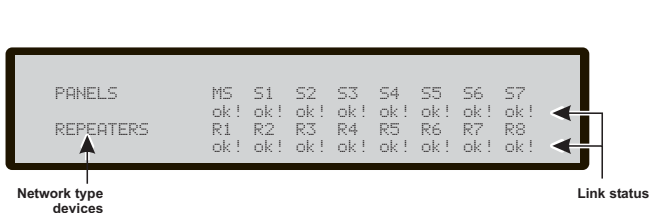

Figure 23 Example of Display: View Network (MFI modules and Repeaters).

6 KEY- COMMUNICATORS

The **6 Key** is used to view the Communicator connected to the control panel, see Figure 24. In addition to the Firmware version, the FC500IP module status and the address will be displayed.

In this phase:

Alphanumeric keypad No function is related to Alphanumeric keypad.

Cursor Keys No function is related to the **UP, Down, Right, Left Key**.

ESC Key Use the **ESC** key to cancel the operation and to step back to previous page.

ENTER key No function is related to the **ENTER** key.

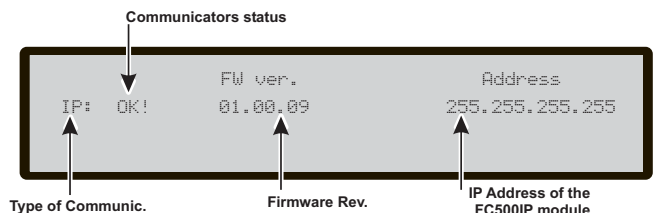

Figure 24 Display Communicators.

7 KEY- View Option

The **7 Key** activates, in the ANALYZE MENU, the viewing of programmed system options, see Figure 25. The status of the DAY/NIGHT MODE options will be indicated using the following abbreviations:

- DAY: day mode
- NGT: night mode
- AUT: automatic mode.

In this phase:

Alphanumeric keypad No function is related to Alphanumeric keypad.

Cursor Keys No function is related to the **Up, Down, Right** and **Left Key**;

ESC Key Use the **ESC** key to cancel the operation and to step back to previous page.

ENTER key No function is related to the **ENTER** key.

8 KEY - View Log

Use the **8 Key** to select **View LOG** (see Figure 26) or directly from the **STANDBY status**.

The option **View Log** of the menu **View parameters** will allow you to view the stored events in the Log of the fire control panel.

This Control panel can store the last 4000 occurred events.

When the Log is full, the oldest event will be deleted, so the newest can be stored.

 Use the option **CLEAR LOG** of the **Modify** menu to delete the Log events.

The following data will be stored in the LOG:

- Event description;
- Event number;
- Description of the device (Panel or Repeater) that generated the event;
- Description of the item that generated the event;
- Time and date of the event;
- Address of the Item which generated the event.

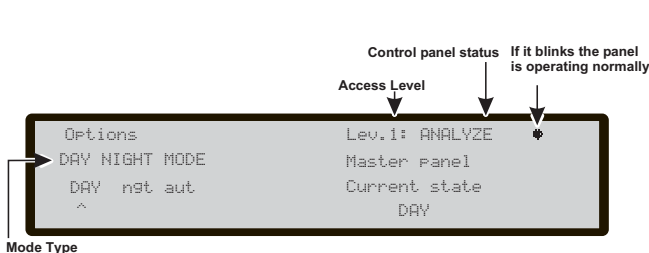

Figure 25 Display: View Option.

View Log

From **MAIN page** directly, the User, without password, can arrive to **View Log** see Figure 26.

The Event Class field displays the class of the event currently displayed, the possible values are:

- RESTORE
- ALARM
- ALARM+DLY
- WARNING
- FAULT
- GENERIC
- WALK TEST.

In this phase:

Alphanumeric keypad Used to activate the display filters.

1: Alarm events only, **2:** Delay to Alarm events only, **3:** Warning events only, **4:** Walk Test events only, **5:** Fault events only, **6:** Restore events only, **7:** Generic events only.

Cursor Keys Use the **UP** Key to select the previous available event;

Use the **Down** Key to select the next available event;

Use the **Right** Key to view the next available data;

Use the **Left** Key to view the previous available data.

ESC Key Use **ESC** key to cancel the operation and to step back to main page.

ENTER key No function is related to the **ENTER** key.

 If the events are linked to the devices, the zone label alternates with the point label every 3 seconds. If the zone has not been associated with the point, only the point label will appear.

 If the displayed events are filtered by type, "*" will immediately begin to blink to the right of the event number.

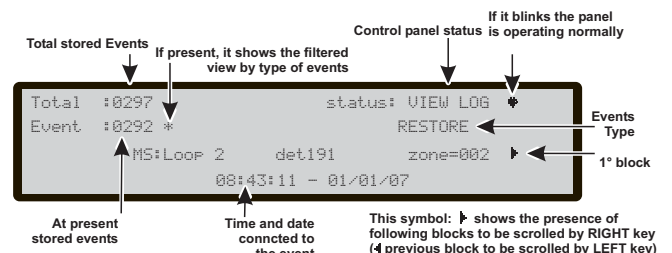

Figure 26 Display: View LOG.

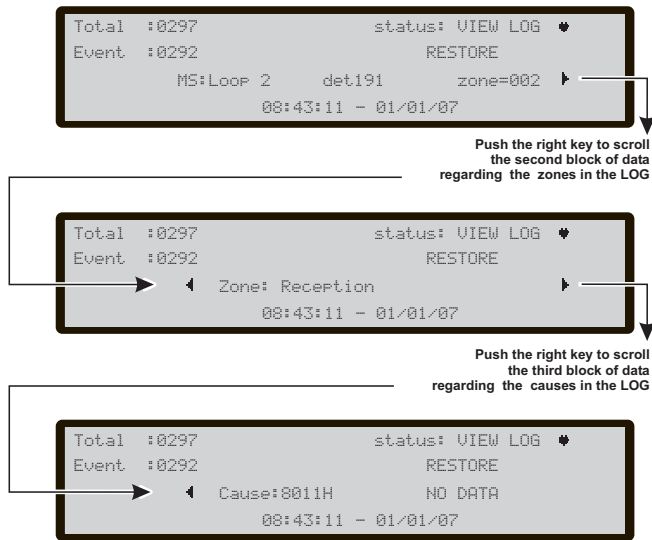

Figure 27 View LOG: scroll with RIGHT key.

9 Key - View FW version

The option **Ver. FW** of the View Parameters Menu allows you to view the Firmware version of Fire control panel.

Use the **9 key** to view the Firmware version of Fire control panel (see Figure 28), in this phase:

Alphanumeric keypad No function is related to Alphanumeric keypad.

Cursor Keys No function is related to the **Up, Down, Right** and **Left** Key.

ESC Key Use the **ESC** key to cancel the operation and to step back to MAIN page.

ENTER key No function is related to the **ENTER** key.



Figure 28 Display: Viewing FW version.

0 Key-Panel

By pressing the **0 key**, in the **ANALYZE** menu, it is possible to read:

- the fire panel ID
- the serial number of the Fire Panel (displays the electronic board serial number composed by eight hexadecimal digits);
- the version of the PCB;
- the type of power supply on board;
- the type of batteries on board
- the presence of the auxiliary controller (see Figure 29).

In this phase:

Alphanumeric keypad No function is related to Alphanumeric keypad.

Cursor Keys No function is related to the **Up, Down, Right** and **Left** Key;

ESC Key Use the **ESC** key to step back to ANALYZE menu page.

ENTER key No function is related to the **ENTER** key.

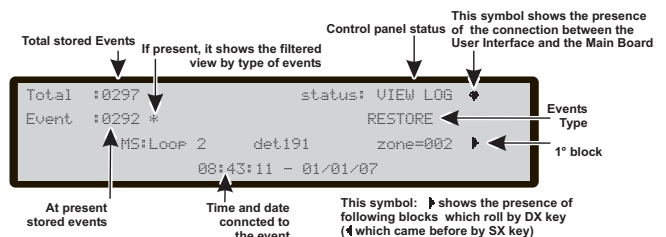



Figure 29 Display: Viewing Panel info.

View Lists

Directly from the **MAIN** page, press **4 =MORE** Key and then **2= View Lists**.

The option **View Lists** allows you to view:

- 1- Dis. Zone-Disabled zones
- 2-Dis. Device-Disabled devices
- 3-Dis. Part-Disabled Parts
- 4-Walk test - Walk test Zones
- 5-Faults List
- 6-Warnings List
- 7-Dev. in test (Devices in test).

 The lists containing data (not empty) are indicated by the blinking of the corresponding number

In this phase:

Alphanumeric keypad Alphanumeric keypad is used to select and access the View function (see options above).

Cursor Keys No function is related to the **Up, Down, Right** and **Left** key.

ESC Key Use the **ESC** key to cancel the operation and to step back to previous page.

ENTER key No function is related to the **ENTER** key.

The field "Item in the list" contains the number of items present in the list at the moment of it opening.

The field "Current item ID" contains the number ID of the currently displayed item.

The field "Kind of list" replicates the name of the list previously selected.

The field "Item info" displays the information about the item currently selected. It shows the location of the SW zone and loop device or the description of a system part plus the related label.

In this phase (second Display in Figure 30):

Alphanumeric keypad 1 Key: to call the enablement page to quickly enable the displayed entity.

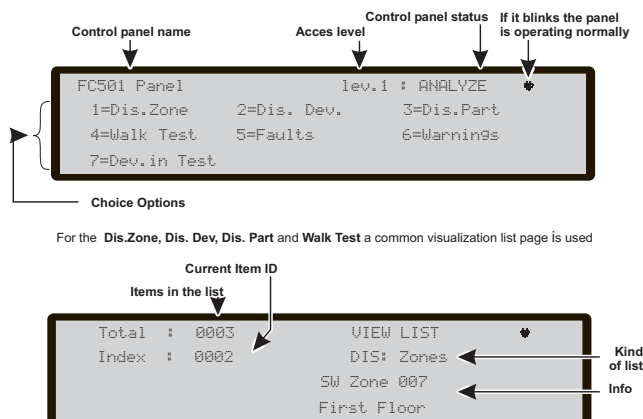

Figure 30 Display: View Lists.

Cursor Keys The **UP** Key, used to navigate the list, displays the next element;
The **Down** Key, used to navigate the list, displays the previous element;
No function is related to the **Right** key;
No function is related to the **Left** key.

ESC Key Use the **ESC** key to cancel the operation and to step back to previous page.

ENTER key No function is related to the **ENTER** key.

MODIFY MENU

For the **MODIFY** option, from the **MAIN** page, press the **3** key.

To access the **MODIFY** Menu:
Enter the User Access code (11111 at default), each digit will be masked by * (asterisk).

The following options are available in this menu:
1-Clear and update the Welcome message (Init MSG) (control panel name),
2- Enter and update L2- User Password,
3- Update Day/Night mode
4- Update Time and Date
5- Clear LOG
6-Zone Walk test.

Figure 30 shows the options for the MODIFY MENU after inserting or modifying the password.

In this phase:

Alphanumeric keypad Use the Alphanumeric keypad to select the options of MODIFY MENU.

Cursor Keys No function is related to the **UP, Down, Right and left** Key.

ESC Key Use the **ESC** key to cancel the operation and to step back to previous page.

ENTER key No function is related to the **ENTER** key.

1 KEY -INIT MSG (Modify panel label)

Use the **1 Key** to enter or update the Panel label.
In this phase:

Alphanumeric keypad The Alphanumeric keypad is used to enter or update the panel label.

Cursor Keys Use the **UP** key to change the selected letter from lower case to upper case;
Use the **Down** Key to change the selected letter from upper case to lower case;
Use the **Right** Key to select the next character to be modified;
Use the **Left** Key to select the previous character to be modified.

ESC Key Use the **ESC** key to cancel the operation and to step back to previous page.

ENTER key Use the **ENTER** key to confirm the label.

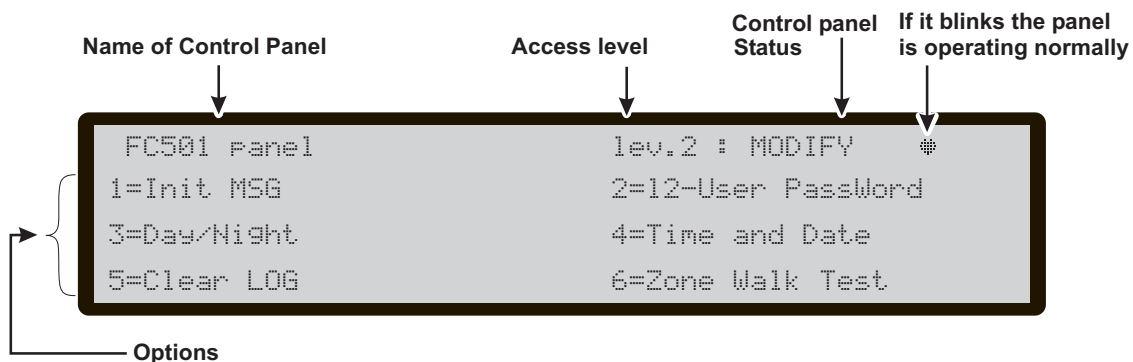

Figure 31 Display MODIFY MENU.

2 KEY - User Password

Use the **2 key** to Modify the User Password (see Figure 32).

■ Insert or Modify Password

Select the option MODIFY, the display will show Figure 32. In this phase:

Alphanumeric keypad Use the Alphanumeric keypad to enter the last 5 digit User password.

To avoid the use of the same password for multiple users, as the first digit of password, the User must enter the number corresponding to his position, see the following.

The first digit for the User 1: is 1
 The first digit for the User 2: is 2
 The first digit for the User 3: is 3
 The first digit for the User 4: is 4
 The first digit for the User 5: is 5
 The first digit for the User 6: is 6
 The first digit for the User 7: is 7
 The first digit for the User 8: is 8.

Cursor Keys No function is related to the **UP, Down, Right** and **Left** Key;

ESC Key Short press: Abort the enter password procedure and exit;

Long press: clear all the entered digits.

ENTER key Use the **ENTER** key to confirm the password and start the password verification process.

If a wrong or empty password is entered the second page in Figure 32, will be displayed for 5 seconds.

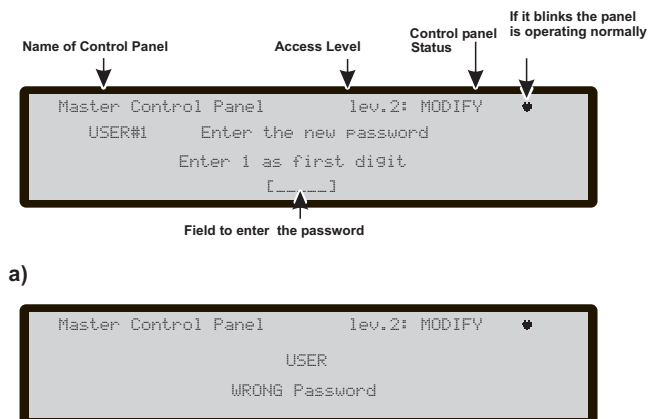



Figure 32 Display: Modify User password.

3 KEY-DAY/NIGHT

If the **3 Key** is pressed, it is possible to change the control panel operating mode: Day mode or Night mode.

The Day/Night mode will be toggled at each key **3** press.

The Day mode indicator light  will change status.

■ Day/Night Mode

The control panel can operate in DAY or NIGHT Mode. If the system is silenced during DAY Mode, SILENCE status will be held until the system is unsilenced (i.e. until new alarms or faults occur). If the system is silenced during NIGHT Mode, SILENCE status will be held until the Night Mode Silence time expires. On power up (at default) the system will set to DAY Mode. During this operating mode, silenced alarms/faults will not be unsilenced automatically.

*This control panel will generate an Instant Alarm if alarm conditions are detected during **Night Mode** or if an alarm is triggered from a Callpoint.*

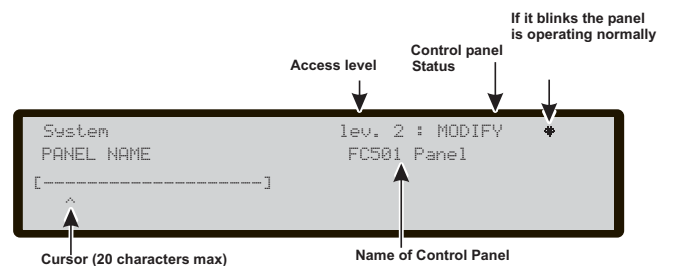

Figure 33 Display Panel label .

4 Key-Time and Date

Use the **4 Key** to select TIME and DATE in the MODIFY menu to enter/change the control panel Time and Date (see Figure 34).

In this phase:

Alphanumeric keypad The alphanumeric keypad is used to enter the Time and Date values.

Cursor Keys No function is related to the **UP Key**; No function is related to the **Down Key**; Use the **Right Key** to select the next value to be inserted/modified; Use the **Left Key** to select the previous value to be inserted/modified;

ESC Key Use the **ESC** key to cancel the operation and to step back to previous page.

ENTER key Use the **ENTER** key to confirm the Time and the Date.

If you enter incorrect values a message will show the error as shown in Figure 34a.

5 Key- Clear LOG

Use the **5 key** to select **Clear LOG** (see Figure 35).

If the user or installer needs to clear the LOG then this option will generate CLEAR LOG in the list of events. This CLEAR LOG event is the last event the user can see in the entire LOG. The installer continues to have access to the entire LOG.

If the 5 Key is selected, confirmation of this deletion will be requested, as all data will be lost.

In this phase:

Alphanumeric keypad No function is related to the alphanumeric keypad.

Cursor Keys No function is related to the **UP, Down, Right** and **Left Key**.

ESC Key Use the **ESC** key to cancel the operation and to step back to previous page.

ENTER key Use the **ENTER** key to confirm the procedure to clear Log.

During the Clear LOG activity the MAIN page will be displayed with the Panel activity field loaded with CLEAR LOG string (see Figure 3435). Once the Log has been cleared, the panel resets.

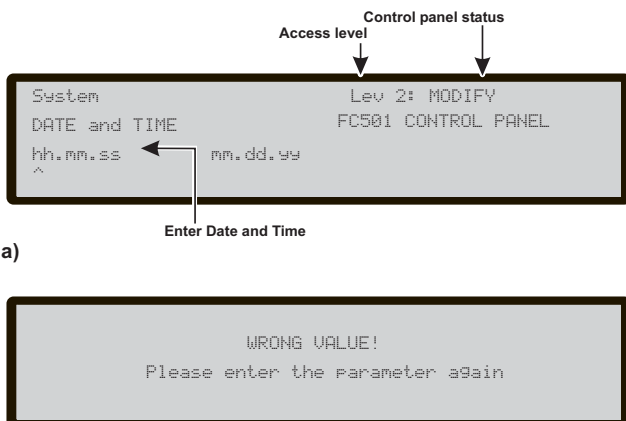

Figure 34 Display Time and Date.

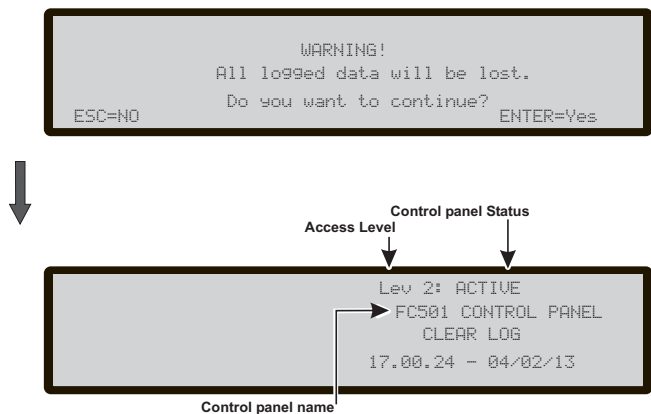



Figure 35 Display "Clear LOG".

6 KEY- WALK TEST

The **Walk Test** option of the **MODIFY** menu will activate the zone programming procedure for the Zone walk test (see Figure 36).

1. If the option **WALK TEST** is selected the user is prompted with the following question: **APPLY TO ALL ZONES? no or YES**. Choose **YES**, which is the default option, and these settings are applied to all subsequent zones in the control panel. Alternatively, select a zone from the screen and the process continues.

 *The option that allows the user to select a specific zone from the screen is available for control panels with firmware 1.10 or above.*

2. Select the devices to put in walk-test mode: **off all det cp**. If **yes** is chosen as the first step, **off** is highlighted as the default choice regardless of the current value of this option. If an option different from **off** is chosen, the process moves on to the next step.
 - If the option **all** is selected, all the devices assigned to zones in **WALK TEST** mode will **NOT** generate an alarm when activated but will reach the **TEST** status.
 - If the option **det** (**DETECTORS**) is selected only the detectors assigned to zones in the **WALK TEST** mode will not generate when activated but will reach the test status.
 - If the option **cp** (**CP**) is selected, only the call-points assigned to zones in **WALK TEST** mode, will **NOT** generate alarm in the case of their activation but will reach the **TEST** status.
3. If the option **SOUNDERS ON (3s)** is selected, the user is presented with the following option: **no** or **YES**. If **YES** is chosen, each test event - input activation - activates the sounders in the same zone for 3 seconds. This zone setting is programmable using the PC software. The default value is **no**.

The presence of a zone in **WALK TEST** mode is signalled by the  **TEST** yellow LED on the User Interface. More than one zone can be put in **WALK TEST** mode at the same time.

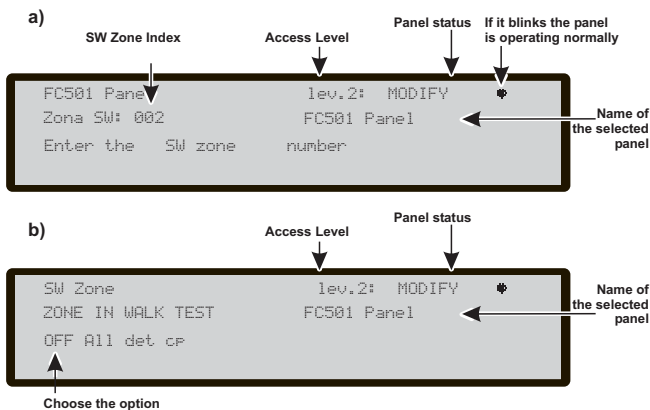

Figure 36 Display WALK TEST option.

Alphanumeric keypad Use to enter the SW zone number.

Cursor Key No function is related to the **UP** and **Down** Keys;
The **Right** key: selects the next: OFF-ALL-det-cp;
The **Left** key: selects the previous: OFF-ALL-det-cp.

ESC Key The **ESC** key cancels the procedure and returns to the programming page.

ENTER key The **ENTER** key accepts the selection and activates the corresponding programming page.

To access the **DISABLE** menu from the MAIN page, you will be asked to enter a "User PIN" password (the default PIN is 11111): each entered digit will be hidden with the * symbol.

This activates the procedure used to enable/disable: Display List of disabled devices, the loop devices (input or output devices), the SW zones, the Outputs of the control panel, the network devices, the Telecom modules, the User password and the RELÈ FIRE Output;

When a device is disabled, the Disable LED will be glowing, and any Alarm or Fault, related to the disabled device, will be ignored.

The disabled and enabled modes are as follows:

Input Devices A disabled input device (Detector, Input module, Conventional Zone module, Addressable Call-points) will not generate ALARM or FAULT status.

➤ To clear ALARM status generated by an input device - **RESET** the fire control panel.

Output Devices ALARM or FAULT status will not activate disabled output devices (Output modules, Addressable Sirens).

➤ To stop the output devices activated by FAULT status - **Disable** the devices concerned.

➤ To stop the output devices activated by an ALARM status - **RESET** the fire control panel.

Output devices enabled during ALARM or FAULT status (programmed), will be activated immediately.

The display (see Figure 18) shows how to select the devices to Disable/Enable.

In this phase:

Alphanumeric keypad Use the Alphanumeric keypad to select the Disable/Enable options.

Use the **1** key to select the **Disab. List**.

Use the **2** key to select the **Disable** option of Loop devices.

Use the **3** key to select the **Disable** option of SW zones.

Use the **4** key to select the **Disable** option of Outputs.

Use the **5** key to select the **Disable** option of Device in the Network.

Use the **6** key to select the **Disable** option of Comunic. devices.

Use the **7** key to select the **Disable** option of the User **Password # 2... # 8** and **Installer # 2**.

Use the **8** key to select the **Disable** option of the **FIRE** relay output.

The option 7 can be enabled only by the Installer #1 password (default 00000)

Cursor Keys No function is related to the **UP, Down, Right** and **Left** Keys.

ESC Key Use the **ESC** key to cancel the operation and to step back to previous page.

ENTER key No function is related to the **ENTER** key.

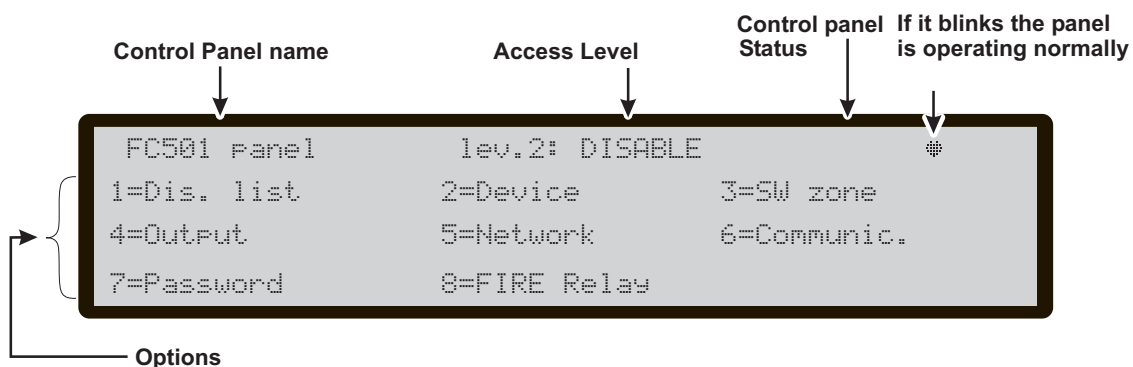



Figure 18 Display **DISABLE** menu.

1 Key - Disable list

Use **1** key, or from MAIN page use **4** key (More) and then **2** to select "View List"; (see Figure 38) In this phase:

 If any of the elements have been disabled, the corresponding number will blink and the Disable indicator light will glow. If the Communicator is disabled, the yellow indicator light (Communicator) will also glow.

Alphanumeric keypad Used to select list to analyze.
 1- To view the list of disabled zones
 2- To view the list of disabled loop devices
 3- To view the list of disabled system parts (Outputs, Communicator).

Cursor Keys No function is related to the **UP**, **Down**, **Right** and **Left** Key;

ESC Key Use the **ESC** key to cancel the operation and to step back to MAIN page.

ENTER key No function is related to the **ENTER** key .

 See paragraph **View List** in the chapter "**View Parameters**".

For Disabled zones, Loop devices and System parts, see Figure 38 (second display). In this phase:

Alphanumeric keypad Press 1 to call the enablement page to quickly enable the displayed entity.

Cursor Keys Use the **UP** key, to select previous item; Use Down key to select next item.
 No function is related to Right and Left Keys;

ESC Key Use the **ESC** key to cancel the operation and to step back to MAIN page.

ENTER key No function is related to the **ENTER** key.

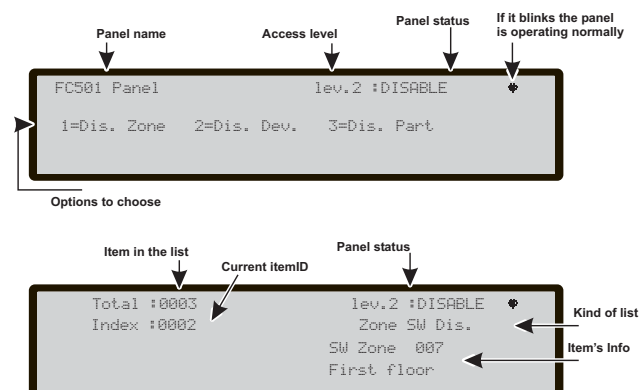

Figure 38 Display "Dis. List" menu.

2 Key - Devices (Disable)

Use the **2** key to select "Device" Disable. The Loop can be selected (see Figure 39).

■ Select the Loop

In this phase:

Alphanumeric keypad No function is related to Alphanumeric keypad.

Cursor Keys No function is related to the **UP** Key; No function is related to the **Down** Key; Use the **Right** Key to select the next Loop; Use the **Left** Key to select the previous Loop.

ESC Key Use the **ESC** key to cancel the operation and to step back to main page.

ENTER key Use the **ENTER** key to confirm and to display the page of the selected Loop.

■ Select the Device

In this phase:

Alphanumeric keypad Use the Alphanumeric keypad to insert the device address.

 If the device is in the system, the square brackets will be shown near the address. If the address does not exist or it is different from that selected in the underlying bar, the arrows will be shown.

Cursor Keys No function is related to the **UP** Key; No function is related to **Down** Key; Use the **Right** Key to select the next available Device; Use the **Left** Key to select the previous available device.

ESC Key Use the **ESC** key to cancel the operation and to step back to main page.

ENTER key Use the **ENTER** key to confirm and to display the page of the selected device.

■ Disable device on the Loop

Selected the Loop and then the device, the Display will show the third display in Figure 39.

The display shows the current status of the device, the possible actions are: ENABLE or DISABLE.

In this phase:

Alphanumeric keypad No function is related to Alphanumeric keypad.

Cursor Keys No function is related to the **UP**, **Down**, **Right** and **Left** Key.

ESC Key Use the **ESC** key to cancel the operation and to step back to previous page.

ENTER key Use the **ENTER** key to confirm and disable the detector. The User Interface moves to the MAIN page signaling a local programming activity followed by a panel reset.

In the case of MULTI CHANNEL MODULE, before reaching the display 3 (see Figure 39) ENABLE/DISABLE, a channel selected display will be shown, allowing the selection of the single channel to ENABLE/DISABLE, display 4 (see Figure 39).

In this phase:

Alphanumeric keypad To select the desired channel 1-8.

Cursor Keys No function is related to the **UP, Down, Right** and **Left** Key.

ESC Key Use the **ESC** key to cancel the operation and to step back to previous page.

ENTER key Use the **ENTER** key to confirm; the User Interface moves to the enabling/disabling page.

3 Key - SW zone

Use the **3** key to select "SW zone"; after the zone has been selected the zone can be Disabled/Enabled (see Figure 40).

■ Select SW zone

In this phase:

Alphanumeric keypad Use the Alphanumeric keypad to select the Zone identification number.

Cursor Keys No function is related to the **UP, Down** key.

Use the **Right** key to select the next SW Zone.

Use the **Left** Key to select the previous SW Zone.

ESC Key Use the **ESC** key to cancel the operation and to step back to MAIN page.

ENTER Key The **ENTER** key accepts the selection and displays the next page, if the zone exists. If the zone does not exist, an error message will be shown: WRONG VALUE PLEASE ENTER NEW PARAMETER.

After 5 seconds, the User interface returns to the page of SW Zone to select.

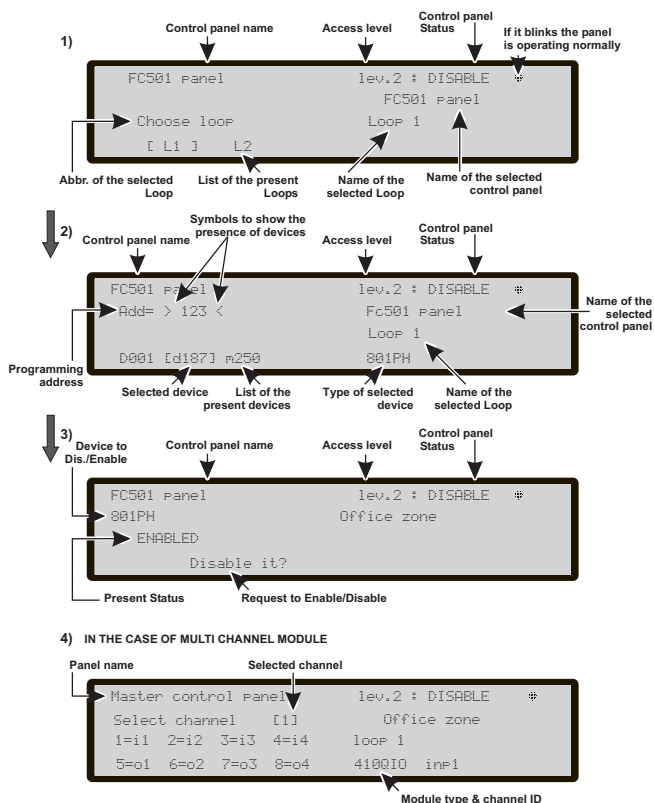

Figure 39 Following Displays of Disable devices.

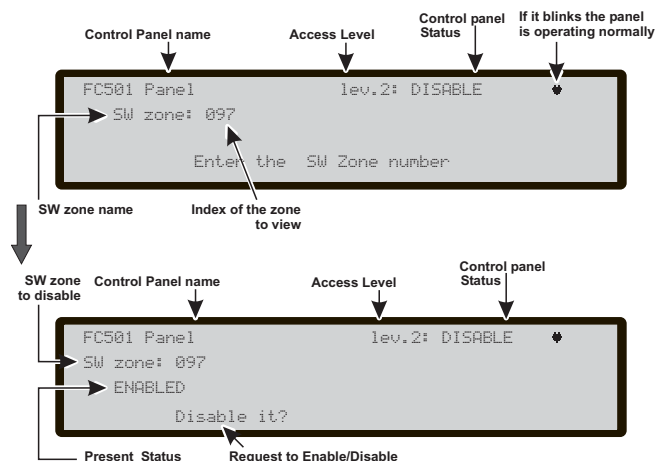

Figure 40 Display "Dis. SW. Zones".

■ **Disable SW Zone**

The display shows the current status of the SW Zone, the possible actions are: ENABLE or DISABLE. In this phase:

Alphanumeric keypad No function is related to Alphanumeric keypad.

Cursor Keys No function is related to the **UP, Down, Right and Left** Keys.

ESC Key Use the **ESC** key to cancel the operation and to return to previous page.

ENTER key Use the **ENTER** key to confirm and disable the SW Zone. The User Interface moves to the MAIN page, signalling a local programming activity followed by a panel reset.

4 Key - Outputs

Use the **4** key to select “Output”; after the Output has been selected, the Output can be Disabled/Enabled (see Figure 41).

■ **Select the Output**

In this phase:

Alphanumeric keypad Use the Alphanumeric keypad to select the Output identification number.

Cursor Keys Use the **UP** Key to show the next type of Outputs;
Use the **Down** Key to show the previous type of Outputs;

The type of Outputs are: SC1 Output (NACFIRE)
SC2
OC Output 1-2

No function is related to the **Right and Left** Key.

ESC Key Use the **ESC** key to cancel the operation and to step back to previous page.

ENTER Key Use the **ENTER** key to confirm.

■ **Disable Output**

In this phase:

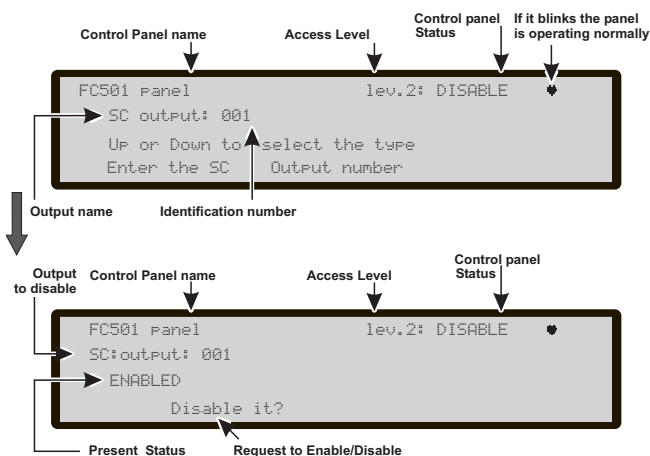

Figure 41 Display "Dis. Outputs".

The display shows the current status of the Output, the possible actions are: ENABLE or DISABLE.

Alphanumeric keypad No function is related to Alphanumeric keypad.

Cursor Keys No function is related to the **UP, Down, Right and Left** Keys.

ESC Key Use the **ESC** key to cancel the operation and to return to previous page.

ENTER Key Use the **ENTER** Key to confirm. The User Interface moves to the MAIN page followed by a panel reset.

5 Key - Network

The **5** Key is used to select the Disable **Network** devices option; after the network device has been selected, will be disabled/enabled accordingly (see Figure 42).

■ **Select the Network device**

In this phase:

Alphanumeric keypad Use the Alphanumeric keypad to select the identification number of Network device.

If the number is incorrect, an error message will be shown: WRONG VALUE PLEASE ENTER NEW PARAMETER.

Cursor Keys Use the **UP** Key to show the next type of network device ;

Use the **Down** Key to show the previous type of network device;

The type of devices are:

- Repeater 1-4
- MFI (1-4)
- RS485NET—(local network interface)

No function is related to the **Right** Key;

No function is related to the **Left** Key.

ESC Key Use the **ESC** key to cancel the operation and to return to previous page.

ENTER Key Use the **ENTER** key to confirm and display the next page.

■ **Disable Network device**

In this phase:

The display shows the current status of the Network device, the possible actions are: ENABLE or DISABLE.

Alphanumeric keypad No function is related to Alphanumeric keypad.

Cursor Keys No function is related to the **UP, Down, Right and Left** Key.

ESC Key Use the **ESC** key to cancel the operation and to return to previous page.

ENTER Key Use the **ENTER** Key to confirm. The User Interface moves to the MAIN page followed by a panel reset.

6 Key - COMMUNIC. (Disable)

The **6** Key is used to select the Disable **Communic.** devices option; after Communic. device has been selected, will be disable/enable; the corresponding **Telecom** module will then be disabled/enabled accordingly.

■ Select the COMMUNIC. device

In this phase:

Alphanumeric keypad Use the Alphanumeric keypad to select the identification number of module.

If the number is incorrect, an error message will be shown: NO ACTION TO BE DONE

Cursor Keys Use the **UP** Key to show the next type of Telecom module.

Use the **Down** Key to show the previous type of Telecom module.

The type of Telecom module are:

- TEL i/f
- Alarm TX
- Fault TX
- IP i/f
- Alarm IP
- Fault IP

No function is related to the **Right** Key;

No function is related to the **Left** Key.

ESC Key Use the **ESC** key to cancel the operation and to return to previous page.

ENTER Key Use the **ENTER** key to confirm and display the next page.

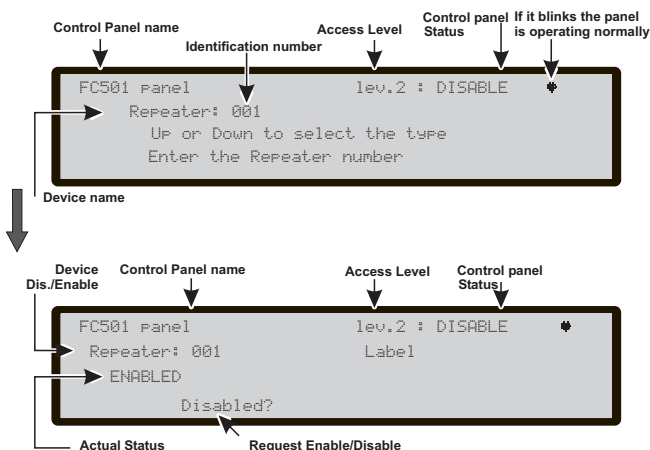

Figure 42 Display Disable/enable Network device.

■ Disable COMMUNIC. device

In this phase: the display shows the current status, the possible actions are: ENABLE or DISABLE.

Alphanumeric keypad No function is related to Alphanumeric keypad.

Cursor Keys No function is related to the **UP**, **Down**, **Right** and **Left** Keys.

ESC Key Use the **ESC** key to cancel the operation and to return to previous page.

ENTER Key Use the **ENTER** Key to confirm. The User Interface moves to the MAIN page followed by a panel reset.

If a module is disabled (TEL i/f or TX Alarms or TX Fault or IP Alarm or IP Fault), the Disabled indicator light will glow, as will the yellow Communicator indicator light.

If the TEL i/f communicator has not been enabled using software (Options page- FireClass Console) and you attempt to enable/disable it, the following text will appear on the display: NO ACTION TO BE DONE

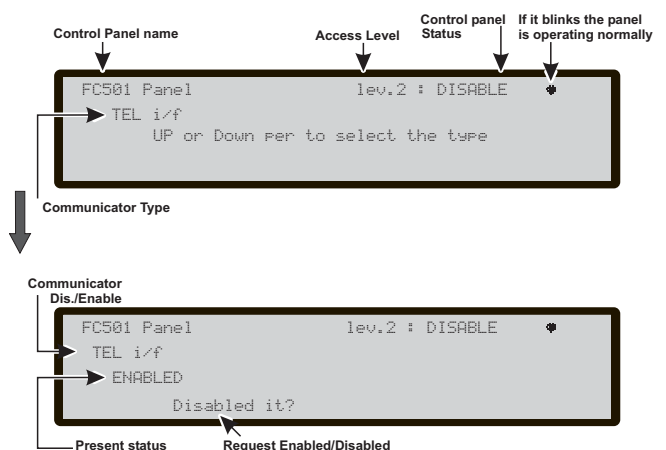

Figure 43 Display Enabled/Disabled Telecom (Communicator).

7 Key-Password (Disable)

This option is enabled only if you enter in the Control Panel using a Master Installer PIN (Default 00000). The Key 7 is used to select the Disable **Password** option, after the option has been selected the corresponding password will be disabled/enabled (Figure 44).

■ Select the Password

In this phase:

Alphanumeric keypad Use the Alphanumeric keypad to select the identification number of Password.

Cursor Keys Use the **UP** Key to show the next type of password;

Use the **Down** Key to show the previous type of password. The types of password are User Password and Installer Password.

No function is related to the Right and Left Keys.

ESC Key Use the **ESC** key to cancel the operation and to return to previous page.

ENTER Key Use the **ENTER** Key to confirm.

■ Disable Password

In this phase, the display shows the current status of the selected Password (User or Installer). The possible actions are: ENABLE or DISABLE.

Alphanumeric keypad No function is related to Alphanumeric keypad.

Cursor Keys No function is related to the **UP, Down, Right and Left** Keys.

ESC Key Use the **ESC** key to cancel the operation and to return to previous page.

ENTER Key Use the **ENTER** Key to confirm. The User Interface moves to the MAIN page followed by a panel reset.

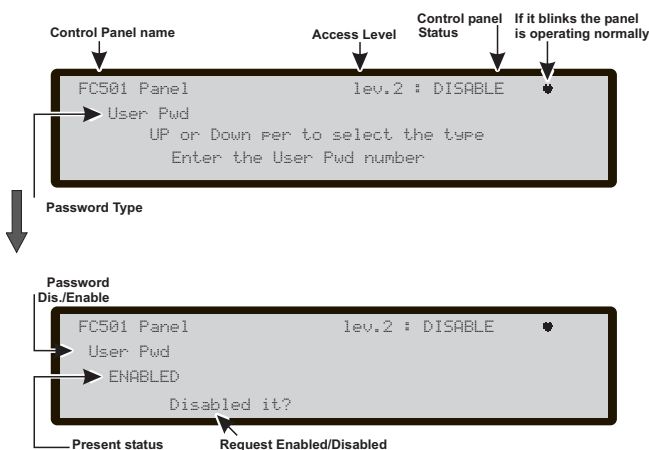

Figure 44 Display Enabled/Disabled Password.

8 Key - Fire Relay

Use the 8 key to select "Fire Relay"; the "Fire Relay" output can be Disabled/Enabled (see Figure 45).

The field "Current enablement status" displays the current enablement status of the selected item.

The possible status are:

"ENABLED"
"DISABLED"

The Item "Action to do" contains the following actions:

"ENABLE IT?"
"DISABLE IT?"

In this phase:

Alphanumeric keypad No function is related to Alphanumeric keypad.

Cursor Keys No function is related to the **UP, Down, Right and Left** Keys;

ESC Key Use the **ESC** key to cancel the operation and to return to previous page.

ENTER Key Use the **ENTER** Key to confirm. The User Interface moves to the MAIN page followed by a panel reset.

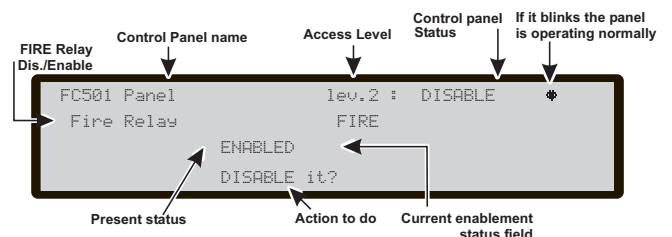

Figure 45 Display Enabled/Disabled FIRE Relay.

Repeater FC500REP Signalling

■ Description of command Keys

ONLY the Lamp/Buzz/Test, Silence Buzzer and Evacuate Control keys can be activated without password (access level L1). All other Control keys can be activated with password (access level L2 and L3) see Table 4.

■ LCD DISPLAY DESCRIPTION

The information on the LCD display is organized as “pages”. There are two kinds of pages:

- MAIN page
- EVENT DRIVEN pages.

The MAIN page allows access to the panel information. It also shows the status of the panel.

The FC500REP MAIN page replicates the panel MAIN page with the following limitations:

- Will never be overwritten by the panel front page.
- Only the View list and View Log pages may be called.
- The ESC long press to return to level 1 is NOT operative.
- View log page description acts as in the panel.
- View list page description acts as in the panel.

■ EVENT DRIVEN page description

The EVENT DRIVEN pages are activated by events in the system and override the page present on the display at that time.

An Event driven page may be overridden by another Event driven page that has a higher priority.

The event driven page behavior is completely under panel control.

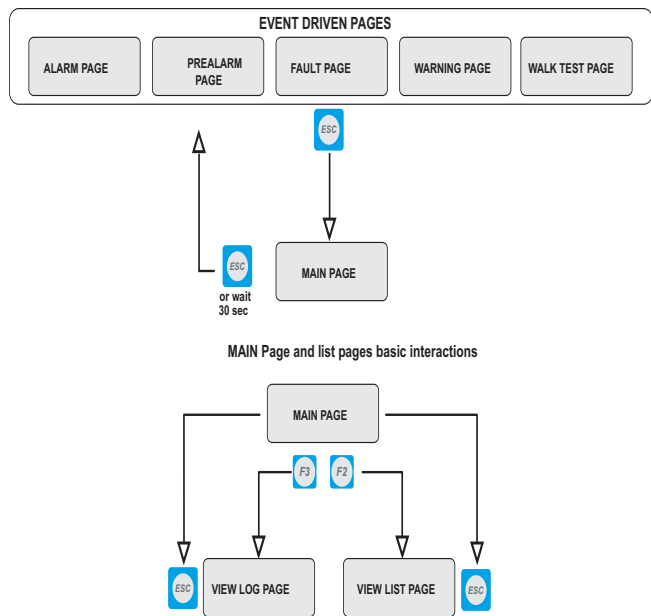

Figure 46 Event driven pages and Main page basic interactions.

The EVENT DRIVEN pages replicate the panel EVENT DRIVEN pages with the following limitations:

- Will NOT be possible to reach the device status page using the “F” keys.
- It is NOT possible to change the display mode in the Alarm or Delay to Alarm pages.

■ Description of Status LED

The Repeater status LEDs are described in the table 5.

KEY	DESCRIPTION
Lamp/Buzz Test	This key can be used to test the buzzer and LEDs. If this key is pressed (when the Control panel is functioning as intended), all the LEDs will glow and the buzzer will emit a continuous beep.
Silence	This key can be used to restore the Silenceable outputs to standby status. Silence status will be held until the Silence key is pressed again in Day Mode , or if the Control panel is operating in Night Mode , until the Night mode Silence time expires or until a new Alarm/Trouble condition is detected.
Investigate	This key can be used to refresh the “Delay to Alarm Time”: if this key is pressed during “ Delay to Alarm ”, the remaining Delay to Alarm time will be increased with the programmed “ Investigation delay ”.
Silence Buzzer	Key to silence the local buzzer of the control panel: the buzzer will operate every time a new event occurs.
Reset	This key can be used to reset the Fire detectors and restore all outputs to standby status (Supervised/Silenceable outputs, NON-Supervised/Non-Silenceable outputs and Alarm zone outputs).
Evacuate	Key to activate the evacuation : if this key is pressed, the system will generate an alarm.
F1, F2, F3, F4	Function keys of the Display; their function varies according to different screens of display.

Table 4 Description of the Repeater keys.

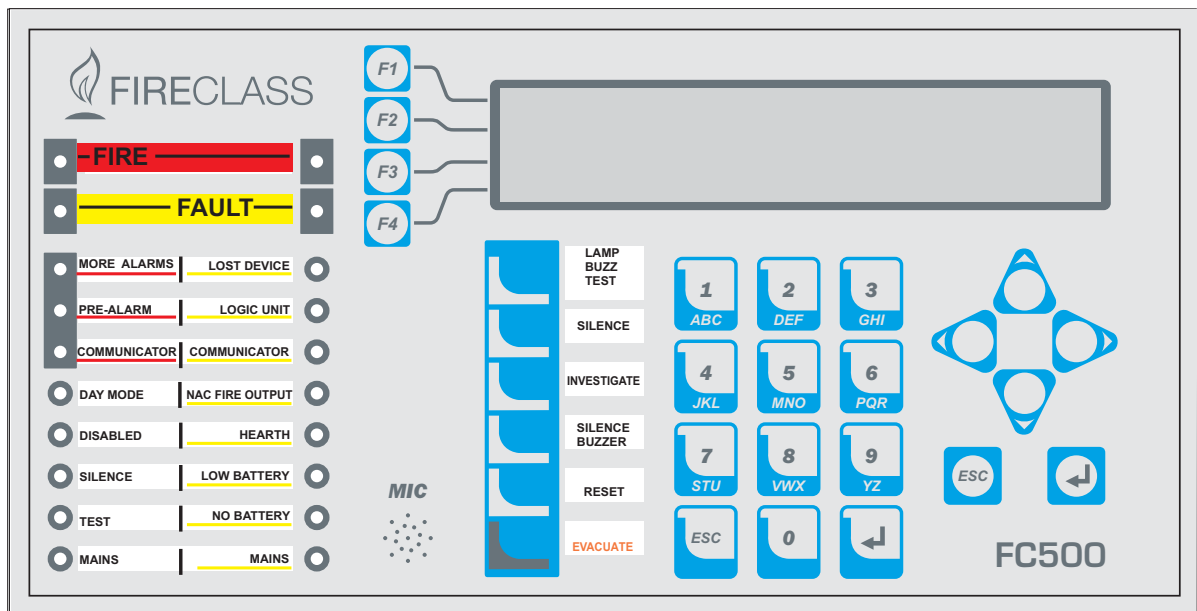

Figure 46 Repeater FC500REP User Interface.

LED	DESCRIPTION
FIRE	Glowing indicates Alarm status. In the event of an Alarm, the Control panel will activate the unbypassed alarm outputs.
More Alarms	Glowing indicates more Alarm status.
Pre-Alarm	Blinking indicates Delay to Alarm status.
Communicator (Red)	Glowing indicates that transmission was successful. Blinking indicates that transmission is in progress. On the display of the control panel it is possible to know the connection type: PSTN, GSM, or LAN network.
FAULT	Glowing indicates the presence of a Fault: the following LEDs or the screen on the display indicate the type of the Fault. Slow blinking indicates a fault event in memory (Reset turns OFF).
Logic Unit	Glowing indicates a blocked Control panel. IMPORTANT: Maintenance required. NOTE – When the Control panel is switched on for the first time, this LED will blink until a Reset has been performed.
Lost Device	Glowing indicates that a Loop device has disappeared (missing address).
Communicator (Amber)	Glowing indicates the Dialer has been disabled; Slow blinking indicates that the dialer has broken down
(SC)Nac Fire Output	Glowing indicates that SC FIRE Output is bypassable (Disabled), Slow blinking indicates the presence of a Fault on SCFIRE Output.
Earth	Glowing indicates a Voltage leakage to Earth. IMPORTANT: Check wiring insulation
Low Battery	Glowing indicates Batteries empty or faulty. If this condition persists, the batteries will be unable to function as intended in the event of blackout. IMPORTANT: New batteries required.
NO Battery	Glowing indicates Batteries empty or disconnected. Check if the connections are correct.
MAINS (amber)	Glowing indicates Mains failure (110/230 Vac) or Switching Power supply fault. During this condition, the Control panel will be powered by the batteries.
Day mode	Glowing indicates that the Control panel is operating in Day Mode OFF indicates that the Control panel is operating in Night Mode.
Disabled	Glowing indicates the Disabled status of any bypassable entity.
Silence	Glowing indicates that Silenceable outputs have been forced to standby by means of SILENCE key; in Day Mode the SILENCE will remain until the SILENCE key is pressed again. While in Night Mode, the SILENCE will end automatically after the Silence Time expires.
Test	Glowing indicates Test conditions on at least one zone.
MAINS (Green)	OFF indicates Mains failure (110/230 Vac), both mains & battery power is lost. IMPORTANT: Power must be restored before the batteries are discharged.

Table 5 Description of the status LEDs.

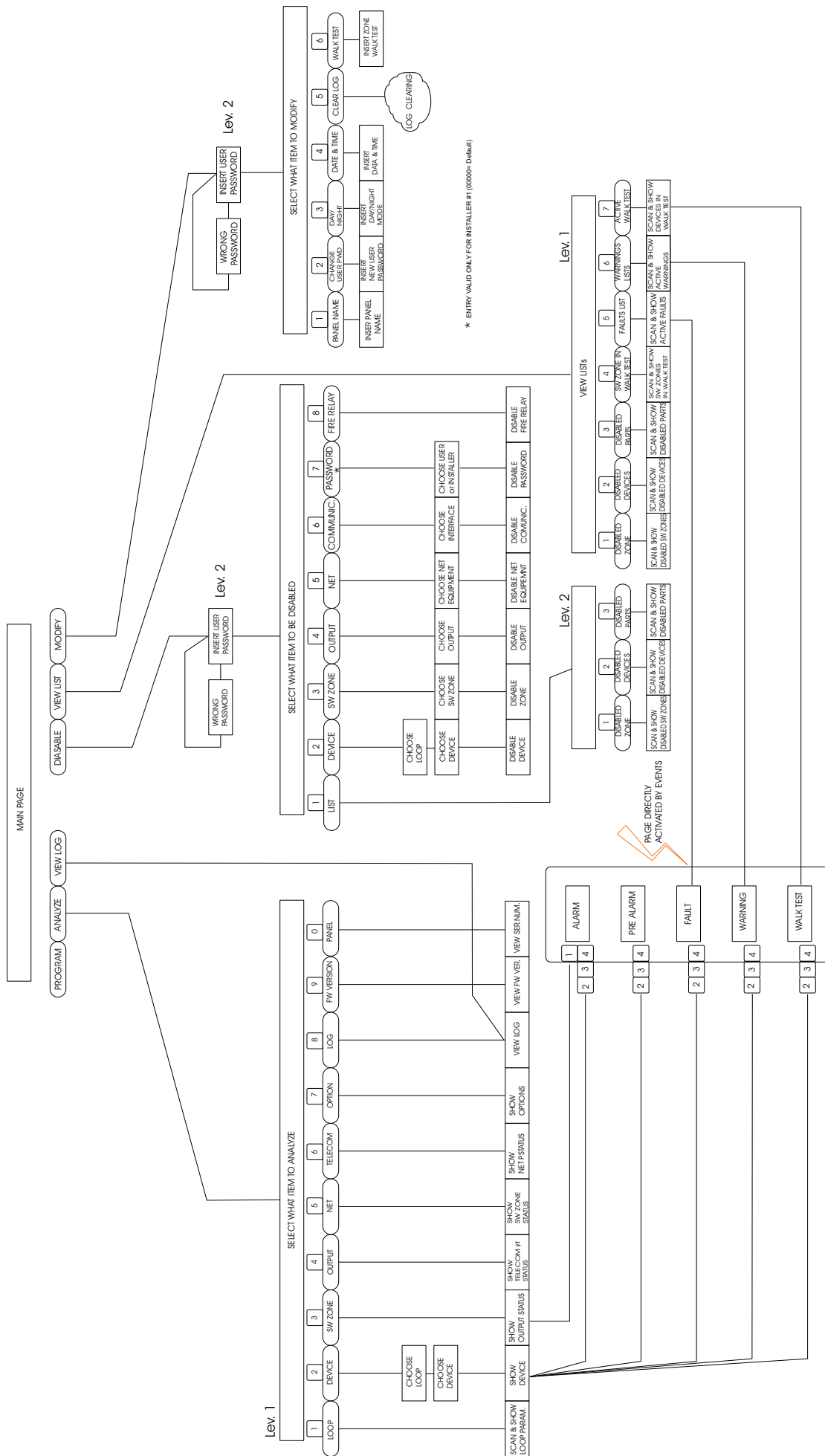

Figure 47 Structure of the User Interface operations at L1 and L2 levels.



0051

Tyco Fire & Security GmbH
Victor von Bruns-Strasse 21
8212 Neuhausen am Rheinflall
Switzerland

13

DoP-2015-4218 (FC501-L)
DoP-2015-4219 (FC501-H)/(FC501-HK)

EN 54-2:1997+A1:2006 **EN54-4:** 1997+A1:2002+A2:2006 **EN 54-21**

Control and indicating equipment with integrated power supply equipment for fire detection and fire alarm systems for buildings with alarm transmission and fault warning routing equipment.

EXPECTED OPTIONS

Fault signals from points
Dependencies on more than one alarm signal: type A and B
Delays to outputs
Disablement of addressable point
Test condition
Output to fire alarm device

EN 54-2 ESSENTIAL CHARACTERISTICS

Performance under fire conditions	Passed
Response delay (response time to fire)	Passed
Operational reliability	Passed
Durability of operational reliability, Temperature resistance	Passed
Durability of operational reliability, Vibration resistance	Passed
Durability of operational reliability, Electrical stability	Passed
Durability of operational reliability, humidity resistance	Passed

EN 54-21 ESSENTIAL CHARACTERISTICS

Performance of transmission	Passed
Operational reliability	Passed
Durability of operational reliability, Temperature resistance	Passed
Durability of operational reliability, Vibration resistance	Passed
Durability of operational reliability, Electrical stability	Passed
Durability of operational reliability, humidity resistance	Passed

EN 54-4 ESSENTIAL CHARACTERISTICS

Performance of power supply	Passed
Operational reliability	Passed
Durability of operational reliability, Temperature resistance	Passed
Durability of operational reliability, Vibration resistance	Passed
Durability of operational reliability, Electrical stability	Passed
Durability of operational reliability, humidity resistance	Passed



0051

Tyco Fire & Security GmbH
Victor von Bruns-Strasse 21
8212 Neuhausen am Rheinflall
Switzerland

13

DoP-2015-4211 (FC500IP in FC501-L/FC501-H/FC501-HK)

EN 54-21

Alarm transmission and fault warning routing equipment for fire alarm systems installed in buildings.

EN 54-21 ESSENTIAL CHARACTERISTICS

Performance of transmission	Passed
Operational reliability	Passed
Durability of operational reliability, Temperature resistance	Passed
Durability of operational reliability, Vibration resistance	Passed
Durability of operational reliability, Electrical stability	Passed
Durability of operational reliability, humidity resistance	Passed

The Declarations of Performance can be found on the product webpage at www.fireclass.net.



© FireClass

Tyco Fire & Security GmbH
Victor von Bruns-Strasse 21
8212 Neuhausen am Rheinflall
Switzerland

Tel.: +41 (0)52 633 02 44
Fax: +41 (0)52 633 02 59

www.fireclass.net

ISTUSFKFC501 7.0 120916 V10